

# **AGREEMENT**

between

## **LOCAL 17 PROFESSIONAL AND TECHNICAL EMPLOYEES**

and

## **CLARK COUNTY, WASHINGTON**

**JULY 1, 2012 - JUNE 30, 2015**

**Appraisers and Other Professionals:** Local 17, Professional and Technical Employees.

**Engineers, Technicians and Other Professionals:** Local 17, Professional and Technical Employees.

### **EXHIBITS AND APPENDICES**

- Exhibit A: Salary Schedules and Represented Classifications
- Appendix A: Appraisers and Other Professionals Unit
- Appendix B: Engineers and Other Professionals Unit
- Appendix C: MOU RE: Tuesday through Saturday shift – Sustainability Specialist
- Appendix D: Memorandum of Understanding –Multi-party Healthcare Committee
- Appendix E: Paid Time Off (PTO) Program



**proud past, promising future**

**CLARK COUNTY  
WASHINGTON**

## TABLE OF CONTENTS

ARTICLE 1. RECOGNITION .....	1
ARTICLE 2. NON DISCRIMINATION .....	2
ARTICLE 3. UNION RIGHTS AND SECURITY .....	3
ARTICLE 4. MANAGEMENT RIGHTS.....	5
ARTICLE 5. LABOR MANAGEMENT COMMITTEE.....	8
ARTICLE 6. UNION REPRESENTATIVES AND ACTIVITIES.....	9
ARTICLE 7. STRIKES AND LOCKOUTS.....	11
ARTICLE 8. JOB ASSIGNMENTS AND CLASSIFICATION.....	12
ARTICLE 9. FILLING OF VACANCIES .....	14
ARTICLE 10. WORK HOURS .....	16
ARTICLE 11. OVERTIME .....	19
ARTICLE 12. COMPENSATION .....	22
ARTICLE 13. VACATION.....	28
ARTICLE 14. HOLIDAYS .....	31
ARTICLE 15. SICK LEAVE.....	33
ARTICLE 16. OTHER LEAVES .....	36
ARTICLE 17. INSURANCE.....	40
ARTICLE 18. OTHER BENEFITS.....	44
ARTICLE 19. DISCIPLINE AND TERMINATION.....	46
ARTICLE 20. GRIEVANCE PROCEDURE.....	49
ARTICLE 21. DEFINITIONS.....	53
ARTICLE 22. SUBSTANCE ABUSE FREE WORKPLACE.....	56
ARTICLE 23. SCOPE AND DURATION.....	63
APPROVAL .....	64
EXHIBIT A Salary Schedules and Represented Classifications .....	65
APPENDIX A Appraisers and Other Professionals Unit .....	68
APPENDIX B Engineers and Other Professionals Unit.....	80
APPENDIX C MOU Re: Tuesday thru Saturday Shift - Sustainability Specialist.....	91
APPENDIX D Memorandum of Understanding - Multi-party Healthcare Committee .....	93
APPENDIX E Paid Time-Off (PTO) Program .....	96

## ARTICLE 1. RECOGNITION

**1.1 Parties.** This Agreement is between Clark County, Washington, hereinafter referred to as the County or the Employer, and Local 17, Professional and Technical Employees, hereinafter referred to as the Union, for purposes of setting forth the mutual understanding of the parties regarding wages, hours, and conditions of employment of those employees for whom the employer has recognized the Union as the exclusive collective bargaining representative.

**1.2 Exclusive Representative.** The employer hereby recognizes Local 17, Professional and Technical Employees as the exclusive bargaining representative for the purposes stated in Chapter 41.56 RCW of all regular full-time and regular part-time employees employed within the bargaining units of this Agreement. The classifications and bargaining units covered by this Agreement are set forth in Appendices A and B. For the purposes of recognition, "regular" employees includes those occupying budgeted positions and working a regular schedule of 1,040 hours or more in any calendar year. The respective bargaining units covered by this Agreement shall exclude all elected, confidential, supervisory (except that lead supervisors shall be included) temporary and part-time (less than 1,040 hours per year) employees.

## **ARTICLE 2. NON DISCRIMINATION**

**2.1** The employer and the Union agree that they will not discriminate against any employee by reason of race, creed, age, color, sex, national origin, religious belief, marital status, mental or physical disability, political affiliation or activity or any other categories of persons or activities protected by federal, state or local statutes, ordinances, rules or regulations. In addition, employees shall not be discriminated against or harassed based on sexual orientation.

**2.2** The employer agrees not to discriminate against any member of the Union for his or her activity on behalf of or because of membership in the Union.

## ARTICLE 3. UNION RIGHTS AND SECURITY

**3.1 Maintenance of Membership.** Except as provided in Section 3.2, all covered employees shall, as a condition of continued employment, maintain their membership in good standing in the Union during the life of this Agreement. New employees shall be enrolled on the first day of the calendar month following their hire date or appointment to a position in the bargaining unit.

**3.2 Religious Tenets Exception.** Employees who are determined by the Public Employment Relations Commission to satisfy the religious exemption requirements of RCW 41.56.122 shall pay an amount equivalent to regular union dues and initiation fees. Those individuals paying religious exemption (non-association) fees will be afforded payroll deductions the same as Union members. Non-association fees will be paid to a non-religious charity mutually agreed upon by the employee affected and the Union to which such employee would otherwise pay the regular monthly dues.

**3.3** In the event an employee member of the Union fails to maintain his/her membership or charitable payment, the Union will notify the County in writing, a “Request for Discharge Letter,” through the Human Resources Department of such employee’s delinquency.

3.3.1 The County agrees to give notice to the employee and the Union within five (5) working days that his/her employment status with the County is in jeopardy and that failure to meet the membership obligation within thirty (30) calendar days from the date such notice is received will result in termination, and that the employee has an opportunity before the end of said thirty (30) calendar day period to present to the affected department any information relevant to why the employer should not act upon the Union’s written request for the employee’s discharge.

3.3.2 In the event the employee has not yet fulfilled membership or charitable payment obligation with the thirty (30) calendar day period noted in the “Request for Discharge Letter,” the Union shall thereafter reaffirm in writing to the County with a copy to the employee, its original written request for discharge of such employee. Unless sufficient legal explanation or reason is presented by the employee why discharge is not appropriate or unless the Union rescinds its request for the discharge, the County shall, as soon as possible thereafter effectuate the discharge of such employee. If the employee has fulfilled the Union security obligation within the thirty (30) calendar day period, the Union shall so notify the County through the Human Resources Department with a copy to the employee.

3.3.3 If the Union has reaffirmed its request for discharge, the County shall notify the Union in writing, with a copy to the affected employee, that the County effectuated the discharge and the specific date such discharge was effectuated, or that the County has not discharged the employee, setting forth the reasons why it has not done so. Any disputes regarding the County’s failure to discharge the affected employee pursuant to this Section shall be adjudicated by the Public Employment Relations Commission.

3.3.4 The Union will notify the County of its initiation fees and dues. The County will deduct such initiation fees and union dues from the wages of the employees and forward

them to the Union each pay period. Each pay period the County shall submit the dues to the address and name provided by the Union, accompanied by a list of dues-paying employees, their salaries, and the amount of their dues. The County and the Union have developed a mutually agreeable dues deduction assignment form for authorization of payments to the Union by payroll deduction.

**3.4 New Hires.** The County agrees to provide the Union with written notification within thirty (30) days of transfers and/or new hires into and separations from the bargaining unit in a fashion mutually acceptable to the parties. A meeting with the Union representative shall be included as part of new employee orientation.

- a. The Union will notify the employer of its initiation fees and dues. The employer will deduct such initiation fees and union dues from the wages of the employees and forward them to the Union each pay period. Each pay period the County shall submit the dues to the address and name provided by the Union, accompanied by a list of dues-paying employees, their salaries, and the amount of their dues. The employer and the Union have developed a mutually agreeable dues deduction assignment form for authorization of payments to the Union by payroll deduction.

**3.5 Printing and Distribution.** The County shall bear the cost of printing and binding this Agreement. The County shall provide copies of the Agreement to the applicable Union for distribution to represented employees. The County shall provide copies to new hires.

## ARTICLE 4. MANAGEMENT RIGHTS

**4.1 Rights Reserved.** The management of the County and the direction of the work force are vested exclusively in the employer subject to the terms of this Agreement. The parties agree that existing established past practices not covered by this Agreement on mandatory subjects of bargaining shall be altered only with agreement of the parties. The County shall notify the Union in writing of proposed changes to the County Human Resources Policy Manual or to any mandatory subject of bargaining not covered by this Agreement. This article does not restrict the right of an employee to use the grievance procedure set forth in Article 20, below.

**4.2** Except as specifically limited by the express terms of this Agreement, the parties recognize the following rights of the County:

4.2.1 Determine the methods, processes and means of providing services.

4.2.2 Increase, diminish or change equipment, including the introduction of any and all new, improved or automated methods or equipment.

4.2.3 Make or change the assignment of employees to specific jobs within the bargaining unit in accordance with their job classification or title.

4.2.4 Hire, transfer and promote including determination of the qualifications, methods and standards thereof.

4.2.5 Discipline regular employees for just cause and discipline probationary employees for any lawful reason.

4.2.6 Determine or change standards and expectations for employee performance and conduct.

4.2.7 Evaluate employees including the use or modification of performance appraisal programs.

**4.3 Use of Temporaries.** The County may employ temporary employees on a seasonal, cyclic, or short-term basis, or to assist during an unusually high workload. A temporary employee normally will not be employed more than 1,040 hours in a calendar year, unless extended with mutual agreement of the Union and the County. The County will notify the Union(s) quarterly of the number and identity, date of hire, classification & department of temporary employees. The County will not rotate temporaries through the same position.

Except where mutually agreed upon, temporaries shall be paid no more than the entry step rate for the classification they have hired to work in.

**4.4 Project Employees.** The County may employ project employees for long term but limited duration projects for up to twenty-four (24) months on a full time basis. Project employees are eligible for selected benefits: vacation, observed and floating holidays, sick leave, medical and dental insurance, and the Employee Assistance Program in the same manner as employees

covered under this Agreement. Project employees shall be required to be members of the Union with rights equivalent to probationary employees but shall not be entitled to bump or displace covered employees when laid off at the conclusion of the project nor shall they be entitled to seniority rights.

**4.5 Use of Alternative Workers and Non-Bargaining Unit Personnel.** The County may, in its discretion, make use of various alternative workers for rehabilitative, societal or other purposes including volunteers, offenders, youth programs, interns, senior citizens, welfare recipients and the disabled or assign tasks to personnel from other bargaining units and non-represented employees provided such activity does not result in the layoff of bargaining unit employees or a reduction in the number of bargaining unit positions. The parties affirm the principle that alternative workers should be used as a supplement to and not in place of bargaining unit members.

**4.6 Contracting Out.** The County may contract out bargaining unit work provided such activity does not result in the layoff of bargaining unit employees or a reduction in the number of employees or positions within the bargaining unit. The County shall provide sixty (60) calendar days notice to the affected Union and its representatives.

**4.7 Performance Evaluation.** The County retains the right to evaluate employees including the use or modification of performance appraisal programs. The County agrees to provide for employee and union input on the development of any new appraisal form or system or a substantial change to forms or systems now in use. The parties further agree to the following elements of a performance appraisal system:

- a. The purpose of performance evaluations is to provide employees with clear expectations and feedback regarding their performance against those expectations and to promote communication between the employees, their supervisor and the department head.
- b. The employer may establish or revise procedures and forms for performance evaluations, so long as such procedures and/or forms are reasonable. Peer evaluations shall not be utilized except that employees in lead positions shall be expected to provide input on evaluations of employees under their lead.
- c. Employees may appeal performance evaluations to the reviewer or second (2nd) level signatory. If still unsatisfied they may appeal to the department head. The department head's decisions shall be final.
- d. Performance Evaluations should be used to document previously raised problems and concerns. Except in unusual circumstances, problems not previously raised should not be included in evaluations. Performance evaluations are not intended to replace or diminish the principle of progressive discipline.
- e. Performance evaluations, including employee comments and reasonable rebuttal materials, shall be included in personnel files. The County shall strictly guard the confidentiality of employees' performance evaluations.



- f. In cases where more than a year has passed since the previous performance evaluation without any intervening issues, the County will not utilize any performance issues from that performance evaluation to hinder an employee's opportunity to seek a promotion or transfer.
- g. Performance evaluations are not to be used solely as a basis for disciplinary action.

## **ARTICLE 5. LABOR MANAGEMENT COMMITTEE**

**5.1** The County and the Union agree to establish a joint committee consisting of three (3) representatives of the Union and three (3) representatives of the County. The purpose of this committee is to discuss matters of concern by either party. Meetings will be held as needed and may be called by either party; meetings will be conducted during the County business hours allowing employee members to participate on paid time. Responsibility for coordinating the meetings will alternate between the parties.

## **ARTICLE 6. UNION REPRESENTATIVES AND ACTIVITIES**

**6.1** The Union shall inform the employer in writing of the names of its officers and stewards who are authorized to represent the Union. Such information shall be kept up-to-date at all times.

**6.2 Access to Workplace.** Union representatives may, after informing the supervisor, visit the work location of employees covered by this Agreement. Access shall be allowed provided it does not disrupt the regular work activities of employees or the department.

### **6.3 Use of County Resources**

6.3.1 The County agrees to furnish and maintain suitable bulletin boards for the Union's use in communicating to members. The Union shall limit its posting of notices and bulletins to such bulletin boards.

6.3.2 The Union may use County communications resources (telephone, voice mail, e-mail, mail distribution, bulletin boards) for communications that relate to the Union's business relationship with the County. All other uses require approval of the County and requests should be directed to the applicable department head or his/her designee.

6.3.3 Use of County facilities for Union meetings shall be permitted, subject to the general rules and conditions for public use of County facilities.

**6.4 Release Time.** Employee officers of the Union or stewards shall be allowed reasonable release time without loss of pay for the purposes of meetings with the employer for collective bargaining, grievances or disciplinary hearings or such other legitimate activities as are mutually agreed. Nothing in this Agreement shall be construed to require employees to receive compensation from the employer for representation activities occurring outside of the employee's regularly scheduled work hours or for such time to be counted as time worked for overtime calculation. Work hours shall not be used by officers, employees or business representatives for solicitation of Union membership, collection or checking of dues, Union meetings or other activities relating to the internal business of the Union.

6.4.1 Employee Union representatives shall request permission from their immediate manager for release time. Such request shall be granted provided release time does not unreasonably detract from their work performance and is in compliance with the above requirements as to the nature of the activity.

6.4.2 Employee Union representatives shall be allowed one hour of release time preceding or following meetings with the employer for preparation/debriefing activities.

6.4.3 The Union may use County communications resources (telephone, voice mail, e-mail, mail distribution, bulletin boards) for communications that relate to the Union's business relationship with the County. All other uses require approval of the County and requests should be directed to the applicable department head or his/her designee.

**6.5 Union Business Leave.** Each bargaining unit shall be granted two (2) days per year Union Business Leave for use by Officers and stewards for Union conferences and conventions.

6.5.1 The Union may ask and the County may grant Union leave for up to one (1) year. This leave shall apply to one (1) person at any one time and shall only be granted to allow the individual to perform duties for the Union.

6.5.2 Leaves for Union business shall be governed by the provisions of Section 16.6, Other Leaves and Section 17, Insurance.

## **ARTICLE 7. STRIKES AND LOCKOUTS**

**7.1** During the life of and for the duration of this Agreement, including any status quo period following the expiration of this Agreement, the Union, including agents, officers, representatives, and bargaining unit members shall not engage in, acquiesce in, observe or encourage any strike, slowdown, primary picketing, sick-out, sit-down, or other disruption or stoppage of work at any County facility or at any location where County services are performed nor shall there be any lockout of bargaining unit members by the County. If any such activity takes place, the Union will immediately notify all Union agents, officers, representatives, and bargaining unit members engaging in such activity to cease and desist, and the Union shall publicly declare by letter to the Board of County Commissioners and the Human Resources Department that such activity is in violation of this Agreement and is unauthorized. In the event the Union fails to fully and faithfully discharge its duties under this Article, the Employer shall be entitled to recover its losses incurred as a result of activity in violation of this Article. In the event of a lockout in violation of this Article, affected employees shall be entitled to be made whole for any wages, benefits and rights lost as a result of such lockout. Any employee engaging in any activity in violation of this Article may be subject to immediate disciplinary action or discharge and the only matter related to such action which may be subject to appeal is the question of whether or not the employee engaged in such activity.

## ARTICLE 8. JOB ASSIGNMENTS AND CLASSIFICATION

**8.1 Work Assignments and Duties.** The employer may make or change the assignment of employees to specific jobs within the bargaining unit in accordance with their specific job classification or title.

8.1.1 **Work Out of Class.** Employees in certain work-out-of-classification assignments may be eligible for additional compensation as provided by Section 12.8.

8.1.2 **Career Development.** Employees may be assigned higher-level work for training and development purposes on a limited term basis. The Department shall make every effort to distribute such assignments on an equitable basis. Assignments of employees to a position in a higher-level classification under this Section shall normally be for a maximum of sixty (60) days unless otherwise agreed or work-out-of-classification pay is offered. Employees shall be informed in writing of the purpose of the assignment and its expected duration. Career Development opportunities shall not be used to prevent the filling of vacant positions.

8.1.3 **Alternate Staffing.** Alternate staffing is defined as the budgeting of a position at more than one classification level within a job series. Employees filling alternately staffed positions may be assigned duties at any of the classification levels of the position and shall be eligible for promotion when performing fully satisfactorily at the higher level in the judgment of the department. Classifications which are alternately staffed are listed in the County pay plan.

### 8.2 Reclassification.

8.2.1 Job classifications shall be defined by the current class description for each of the job class titles covered by this Agreement. The County may revise and update classifications to reflect current duties and qualifications for each classification. The Union shall be provided notice of any substantial changes and afforded the opportunity to bargain the effects of the change with respect to mandatory subjects of bargaining.

8.2.2 Employees who believe they are misclassified or have been assigned work outside of their current classification must notify their supervisor or manager in writing. If the department agrees that a reclassification is appropriate the supervisor or manager will request a study of the position(s) by Human Resources. If the employee's department disagrees with the request, they shall so notify the employee in writing within thirty (30) days. If the employee still disagrees, they may appeal the decision to the Human Resources Department. The Human Resources Department will notify the employee within sixty (60) days as to whether the position warrants study and an anticipated date for study. The effective date of any change will be the date of the adoption of the study or the beginning of the seventh (7th) month following receipt of the official request by the Human Resources Department, if the study has not been completed within six (6) months.

8.2.3 When a position is reclassified, the incumbent shall be continued in the position when the following criteria are met:

- a. The change in duties evolved over a period of time, generally six (6) months or longer (versus occurring instantaneously, such as via reorganization) and;
- b. The incumbent has occupied the position and has performed substantially all the duties of the new classification for six (6) months and;
- c. The incumbent meets all of the published minimum requirements of the new classification.

8.2.4 If these qualifications are not met the employee may continue in the position as an under fill for up to twelve (12) months or be reassigned to another vacant and suitable position for which the employee is qualified in the same classification in the department. If there is no position available and an under fill is not practical, the employee shall be laid off.

**8.3 Salaries for New/Revised Classifications.** When a new classification is required or a substantial change is made to an existing job classification in the area of an "upward" change in responsibilities or qualifications the employer will develop/revise the classification description, proposed salary and proposed bargaining unit assignment. The salary range for the new/revise classification shall be established following employer procedures so that the salary of the new class is equitable in comparison to existing bargaining unit classes. The Union shall be provided notice of the allocation and afforded the opportunity to negotiate as to the salary and bargaining unit allocation. The employer may effect the proposed salary pending negotiations. If the parties agree to a change to the salary/classification, the change shall be retroactive to the County's original approval date.

## ARTICLE 9. FILLING OF VACANCIES

**9.1 Vacancies and Posting.** Except as otherwise provided herein, job postings to fill new or vacant budgeted full or part-time bargaining unit positions shall be distributed via e-mail and available on the County LAN (K:\COUNTY\HRCOUNTY\JOBANN). Departments without access to electronic communications will receive a hard copy of the announcement for posting on employee bulletin boards. Employees interested in positions in specific classifications must follow the posting procedures. The filing period shall be a minimum of ten (10) working days unless otherwise agreed. Such notice shall include the classification, salary, description of the duties of the position, qualifications, knowledge, skills and abilities and selection process. Only qualified candidates who apply within the established filing period will receive consideration for such vacancies.

**9.2 Classification Recruitments.** Recruitments may be conducted on a position-by-position basis or on a classification basis. Classification recruitments shall clearly specify that the recruitment may be used to fill future vacant positions. When a recruitment is conducted on a classification basis, the pool of qualified candidates may be used to fill multiple current and future vacancies within a classification for up to twelve (12) months from the final posting date or as otherwise provided by the appendices to this Agreement. Employee-candidates within the pool shall be referred to available vacancies based on their overall qualifications as well as specific qualifications, skills and preferences for particular vacancies.

### 9.3 Promotional Opportunities.

9.3.1 When, in the judgment of the Human Resources Department, sufficient candidates from within the County are qualified, available and interested, the recruitment may be restricted to internal candidates. Promotional recruitments may be further restricted to employees of a particular bargaining unit or department.

9.3.1.1 Vacant positions may be posted on a simultaneous or internal/external basis, based upon the following guidelines:

- a. All external applications will be collected directly by the Human Resources Department.
- b. The County shall first review and consider internal applications prior to reviewing any external applications.

9.3.2 Employees may apply for open recruitments and will receive consideration if they meet all required qualifications. When the selection decision is between external and internal candidates and the knowledge, skills, and abilities of the candidates are substantially equal, preference shall be granted to internal candidates, first within the Department, then within the bargaining unit, then other internal candidates.

9.3.3 When the selection decision is between two or more internal candidates within the bargaining unit who are entitled to preference under Section 9.3.2, bargaining unit



seniority shall prevail where the qualifications, knowledge, skills and abilities of the candidates are substantially equal.

**9.4 Posting Alternatives.** As an alternative to posting, the appointing authority may elect to fill positions by any of the following means. Only qualified employees may be appointed by these means.

9.4.1 **Transfers within or between classifications.** See Appendix A Section 5.0 or Appendix B, Section 3.0.

9.4.2 **Demotions.** Voluntary and involuntary (as provided in Article 19) demotions may be made only to vacant and available positions.

9.4.3 Transfers and demotions of a qualified employee as an alternative to layoff.

9.4.4 Through a bumping or displacement procedure prescribed by this Agreement.

9.4.5 Temporary employees may be appointed without a competitive posting with consent of the department head only for the specific position that they held as a temporary employee and if they held that position for a minimum of six (6) months. Converted temporary positions that represent a promotional opportunity for regular employees may not be filled without a competitive posting.

9.4.6 By appointment of the incumbent of a position that has been reclassified (upwards, downwards or laterally) and who meets the criteria required to be continued in the position as provided by Section 8.2.

9.4.7 When a position and incumbent are moved to another department or division through reorganization or other means.

9.4.8 To accommodate the transfer or demotion of an employee from another classification due to temporary or permanent disability.

9.4.9 To accommodate job sharing arrangements as provided by this Agreement.

9.4.10 By appointment of a laid off employee from a recall list.

9.4.11 By reinstatement of an employee who resigned from a position in the same classification and left in good standing within twelve (12) months prior to the reinstatement. However, reinstatement may not be used in lieu of promotional recruitments. Employees are only eligible for reinstatement to classifications typically recruited for from the outside. Employees who, pursuant to this provision are reinstated to their former classification within twelve (12) months of separation shall be entitled to bridge their seniority for all purposes except layoff. Their seniority date shall be considered the former date of hire, less the break in service.

## ARTICLE 10. WORK HOURS

**10.1 Employee Work Schedules.** Except as otherwise established by the appendices to this Agreement, the available work schedules shall be one of the following:

- a. Five (5) consecutive days of eight (8) consecutive hours, excluding lunch periods, followed by two (2) days off.
- b. Four (4) days of ten (10) hours, excluding lunch periods. Such 4-10 schedules shall provide a minimum of two (2) consecutive days off in each 7-day workweek.
- c. Four (4) days of nine (9) hours and a day of four (4) hours, excluding lunch periods.
- d. Eight (8) days of nine (9) hours and one day of eight (8) hours, excluding lunch periods, during a two (2) week period.
- e. Other alternative work schedules providing there are no inherent additional payroll costs to the County.

10.1.1 The county may continue to utilize schedules for which Saturday or Sunday is a regular work day for those work units which operate on a 7-day basis and for those classifications for which one or more employees are currently working a shift which includes Saturday or Sunday. The extension of Saturday or Sunday shifts to new classifications or work units requires mutual agreement of the parties.

10.1.2 Except in cases of emergency or other unavoidable circumstances beyond the County's control, employees shall be notified in writing of permanent changes in the work schedule at least seven (7) days in advance of their effective date. Schedule changes made in non-emergency situations with less than seven (7) days notice shall result in the payment of overtime for all work hours outside of the normal shift until the seven (7) day notice period has elapsed.

**10.2 Workday.** A workday shall begin between 6:00 AM and 9:00 AM at the employee's regularly assigned workstation unless an earlier or later starting time is established by the department.

### **10.3 Alternative Schedules and Changes.**

10.3.1 Employees or the County may propose alternative work schedules within the limits of a maximum forty (40) hour per week schedule and such schedules may be established by mutual agreement of the Union and the County. No work schedule is permitted which would result in the payment of overtime for hours worked during the regular work shift. This Section is intended to address long term or continuing schedule changes. If an employee requests an alternative work schedule, the County will consider the request and respond in writing with the approval or denial (including the reasons for the denial) within 30 calendar days of the request.

10.3.2 With advance approval of the appropriate level of management (as determined by the Department), employees may “flex” their schedules within a work week, for example working a nine (9) hour day followed by a seven (7) hour day to accommodate personal or work situations or to balance a holiday work week as described in Article 14.3.1. This Section is intended to address occasional or intermittent changes to the schedule.

**10.4 Meals and Breaks.** All employees shall have one unpaid meal period at the approximate midpoint of each work shift of five (5) hours or more and two (2) paid rest periods of fifteen (15) minutes each, one (1) in each half of a full-time shift. An employee who normally receives a one half (½) hour meal period may request a one (1) hour meal period or vice versa. Employees may not forego a meal period to curtail the length of their working day.

**10.5 Job Sharing.** Job Sharing is a type of alternative scheduling in which two employees of the same job classification share the work schedule and duties of a single full-time position. Job Sharing proposals from employees may be considered by individual departments when it can be shown that the proposal can be implemented without significant adverse effects on the effectiveness of County services. Job Sharing is a voluntary arrangement and may be considered only when no significant extra costs above those of a single full-time employee will be incurred by the County. Job sharers must be in the same job classification.

10.5.1 Initial and continuing approval of the Job Share arrangement will be contingent on both partners meeting all of the required qualifications for the job and performing at a fully effective performance level.

10.5.2 Supervisory practices such as salary increases, performance evaluation and discipline will take place separately with each partner.

10.5.3 The County reserves the right to rescind a Job Share arrangement that has failed to meet the requirements of this policy or the employees may elect to terminate the arrangement (including by one of the job sharers resigning), subject to thirty (30) days notice. If the arrangement is terminated, and there is no agreement regarding who will resign or assume full-time responsibilities, the matter will be decided on the basis of seniority. The parties to a terminated Job Share arrangement have the option to resign or transfer to an available position. If either partner resigns, transfers or is terminated, the other partner must assume the full-time responsibilities until an acceptable partner is obtained.

10.5.4 Earned vacation, sick leave, holiday hours and participation in the Washington State Department of Retirement System (DRS) will be prorated according to the number of hours worked (e.g. Job Share partners scheduled to work twenty (20) hours weekly will accrue fifty (50) percent of the earned vacation, sick leave and holiday hours of a full-time employee).

10.5.5 See Article 18 for Other Benefits

10.5.6 Additional hours worked over the scheduled amount shall be paid at the straight time rate and shall not result in a change in the division of health and insurance benefits.

Overtime shall be payable for hours worked by either partner in excess of forty (40) hours per week or as otherwise provided by this Agreement.

10.5.7 Seniority for step increases and layoff will be based on the seniority of each of the Job Sharers individually. Seniority for promotional consideration shall be determined as provided for this Agreement.

**10.5.8 Application Procedure.**

- a. An employee currently in a full-time position who desires a Job Share arrangement must submit a written proposal to their Department Head/Elected Official. The proposal should include the following information:
  1. Names of employees who will Job Share;
  2. Position in which the Job Share is desired;
  3. Proposed work schedule for each employee;
  4. Proposed method of allocation and coordination of job responsibilities between the Job Share employees;
  5. Proposed procedures and routines for ensuring the information flow is maintained; and
  6. Proposed division of County insurance benefits.
- b. Upon receipt of the request, the Department Head/Elected Official and Human Resources will evaluate the proposal and respond to all below listed parties within thirty (30) days. The final written plan must be signed by both Job Share partners, the Department Head/Elected Official, Human Resources, and the Union.

## ARTICLE 11. OVERTIME

### 11.1 Work periods for Overtime Calculation.

11.1.1 **Work Periods for Overtime Calculation.** Except as provided below, the work week for overtime calculation shall be the period of seven (7) consecutive twenty-four (24) hour days beginning with the reporting time following the employee's regularly scheduled days off ("weekend"); for example, 8:00 AM Monday to 7:59 AM the following Monday. The daily work period shall be the period of twenty-four (24) consecutive hours commencing with the employee's scheduled start time on each scheduled day of work.

11.1.2 For work schedules of four (4) days of ten (10) hours, the work week shall be the period of seven consecutive twenty-four (24) hour days beginning on Sunday at 12:00 AM. The daily work period shall be the period of twenty-four (24) consecutive hours commencing at 12:00 AM on each scheduled day of work. Other alternatively scheduled work weeks will have an established beginning date and time, from which, overtime eligibility is established.

11.1.3 An employee requested to come in to work prior to the regular starting time shall have the option of going home at the end of eight (8), nine (9) or ten (10) hours, being paid at the straight time rate, or working to the end of the regular shift with the additional time at overtime rates, provided the supervisor does not have additional work that is necessary.

**11.2 Compensation for Overtime.** Employees normally shall be compensated at one and one-half (1½) times their regular (as defined in Section 12.2.2) rate of pay for hours worked in excess of forty (40) in a week or in excess of their eight (8), nine (9), ten (10) hour or alternatively scheduled daily shift. Except as provided below, the calculation of time worked for overtime purposes shall include paid leave: holidays, floating holidays, vacation, sick leave and comp-time used. Overtime will be paid to the nearest quarter hour.

11.2.1 In the case of employees who are on paid leave for a part of the work day and work outside of their regularly scheduled shift, the employee shall have the option of being paid for the additional hours at the straight time rate or reducing the amount of leave used. For example, an 8-5 employee who is off for two (2) hours due to a medical appointment but who works until 7 PM has worked a total of eight (8) hours and no use of sick leave is necessary. The employee may report either 1) eight (8) hours regular time and two (2) hours sick leave or 2) eight (8) hours regular and zero (0) sick leave. Leave need only be charged as necessary to make up the difference between the normal work hours and the hours actually worked. Daily overtime is payable only for hours *worked* in excess of the regular 8, 9, or 10 hour shift.

11.2.2 Holiday time shall be counted as time worked only for the purposes of paying overtime for work outside of the regular schedule. Holiday hours paid for a holiday falling on the employee's day off, shall be paid at the straight time rate. For example, a Tuesday through Friday 4-10 employee shall receive eight (8) hours pay (or

compensatory time pursuant to Section 11.2) for a holiday which falls on Monday and shall thus be compensated for 48 straight time hours for the week.

**11.3 Compensatory Time Option.** With authorization of the department and the employee, an employee may elect to be compensated for overtime or holiday work in the form of compensatory time off rather than pay. Such election must be made in advance, either on a standing or ad hoc basis. Either party may require that overtime be compensated in pay. Such compensatory time off may be accumulated to a maximum of eighty (80) hours. Unused compensatory time shall be paid off at the employee's regular rate at the time of termination or transfer to another department.

**11.4** All overtime must be authorized by the employee's Department Head or his/her authorized representative prior to being worked.

**11.5 Callback Pay.**

11.5.1 An employee who is called back to work after completion of his/her regular shift shall receive callback pay as provided herein.

- a. Unscheduled callback, regular work day: Two hours plus time worked, all paid at time and one half.
- b. Unscheduled callback, on regular day off: Two hours plus time worked, all paid at time and one half with a minimum of two hours (on time worked).
- c. Scheduled callbacks, regular workday: Time and one half on hours worked, no minimum hours.
- d. Scheduled callbacks, regular day off: Minimum of two hours at time and one half.

11.5.2 For the purposes of interpreting this Section, the following definitions apply.

- a. An unscheduled callback is defined as a requirement to return to work from off-duty and off-premises status with less than twelve (12) hours notice. It excludes overtime which is an extension of the regular shift – “holdover” overtime. It includes overtime which occurs on the “front end” of the regular shift only if no notice is given – the employee is told to report for duty early with no advance notice. All other overtime and call-ins are considered scheduled.
- b. Regular work day callbacks are those which occur during the normal workweek – “between” the employees regularly scheduled workdays.
- c. Day off callbacks shall be considered to be those which occur after midnight following the last day of work in the work week and before the scheduled start time on the first day of the next work week. For example, for a Monday-

Friday, 8-5 employee, the qualifying period would be from midnight Friday to 8:00 AM Monday.

- d. "Minimum" pay is defined as a guarantee of a specified number of hours if the time worked on the callback is less than the guaranteed minimum. It is paid at the time and one half rate.

**11.6 Assignment of Overtime.** Overtime assignments shall be based on policies and procedures established at the department level. The employer will attempt to meet its overtime requirements on a voluntary basis. In the event there are insufficient volunteers to meet the requirements, the employer may require the necessary employees to work. Overtime work that can be performed by either regular or temporary employees shall be offered first to regular employees.

**11.7 Holiday Work Premium.** Regular full-time and regular part-time employees who are required to work on a holiday shall be compensated in pay or compensatory time off at the rate of time and one half for all hours worked. Individual employees who work on both the legal holiday and the day of its observance will receive the holiday work premium on either day but not both. As with overtime, the choice of compensatory time off requires approval of the employee and the department.

## ARTICLE 12. COMPENSATION

**12.1 Salary Schedule** Except as otherwise provided by this Agreement or its appendices, the salary schedules for employees covered by this Agreement shall consist of a salary range of a series of steps as shown in Exhibit A. All employees shall be paid at one of the steps in the range.

### **12.2 Hourly Basis and Calculation.**

12.2.1 Employees covered by this Agreement shall be paid on an hourly basis. The hourly salary for an employee's classification shall be as specified by this Agreement and the County Pay Plan. The employee's annual and monthly salary shall be calculated by multiplying the hourly rate by the hours scheduled to work (2080 per year and 173.33 per month for a full time employee). No use of the term "salary" in this Agreement shall be construed to require or allow employees to be treated as exempt or salaried employees under the FLSA.

12.2.2 **Hourly rate computation.** Employees' regular hourly rates shall include premium pay. The base rate shall exclude all other forms of compensation. Compensation while on paid leave shall include premium pay only if the employee was receiving the additional compensation immediately before and after the time off. All cash-outs of paid leave shall be paid at the employee's base hourly rate of pay.

12.2.3 Employees who work overtime while in a work-out-of-class shall be compensated at the time and one half on the pay rate at the time of the assignment if the employee elects to receive pay for the time. If the employee elects CTO (per Article 11.3), the premium pay will not be included when the time off is taken.

### **12.3 Salary Increases.**

12.3.1 Effective the first of the month following ratification the salary schedule shall be increased by one and three quarter percent (1.75%)

12.3.2 Effective January 1, 2014, the salary schedule shall be increased by two percent (2.0%) as set forth in Exhibit A to this Agreement.

12.3.3 Effective January 1, 2015, the salary schedule shall be increased by two percent (2.0%) as set forth in Exhibit A to this Agreement.

**12.4 Step Increases.** Employees shall normally be hired at the first step and shall be eligible for step increases after twelve (12) months at each step in the range. Unpaid leave of fifteen (15) days or more shall result in an adjustment to the eligibility date for the next step increase. Employees whose eligibility date falls between the first and the fifteenth of the month shall be eligible on the first day of the month. Employees whose eligibility date falls after the fifteenth of the month shall be eligible on the first day of the following month.



12.4.1 Step increases may be withheld or delayed based on disciplinary actions taken in the preceding six (6) months or unsatisfactory job performance. Such cause must be stipulated in writing and be presented to the employee at least thirty (30) days prior to the eligibility date. The employee must be informed as to why the step increase is being withheld, what action he/she must take to obtain the increase and the date on which the employee will next be eligible for consideration for a step increase. The employee's next eligibility date shall not be changed even though the increase may be withheld. Such step increase shall not be withheld or delayed for more than six (6) months.

**12.5 Promotional Increases.** An employee who is promoted shall be placed on the lowest step in the new range which results in an increase equivalent to approximately five percent (5%).

## **12.6 Other Pay Actions.**

12.6.1 **Transfers:** An employee who transfers to a new position within the same classification or to a lateral classification shall retain the same salary and step increase eligibility date.

12.6.2 **Demotions:** An employee who voluntarily demotes shall be placed at the step in the lower classification which most nearly approximates but does not exceed the rate which the employee received in the classification from which he or she is demoting. Such employee shall retain the step increase eligibility date he or she had in the higher classification. An employee who is involuntarily demoted shall be placed at the highest step within the range assigned to the lower classification which results in a decrease and such action shall result in a new eligibility date.

### **12.6.3 Reclassification:**

12.6.3.1 **Upward Reclassification.** For the purposes of this Section, upward reclassification describes those circumstances where an employee is found to be performing the duties of a higher classification and is distinct from realignments as addressed below. When an employee remains in a position, which is reclassified upward, the employee's salary will be adjusted according to the promotional formula above. In addition, such employee shall not be required to serve a new probationary period.

12.6.3.2 **Downward Reclassification.** When an employee's classification is adjusted downward the employee will be placed at the highest step in the new range which does not exceed the former salary. If the former salary exceeds the top step in the new range, his/her wage rate shall be red-circled (frozen) for a period of twelve (12) months from the effective date of the reclassification or until such time as negotiated adjustments advance the top step of the range assigned to the lower classification to the point where it equals or exceeds the employee's red-circled rate – whichever occurs first. The employee shall then be placed at the top step of the range. The County and the Union may, by mutual agreement, decide on a different process by which to address red-circled employees.

**12.6.4 Realignment.** Realignment is the upward adjustment of the salary range of an entire classification based on internal or external compensation relationships. In the event of an upward realignment and except as noted below, employees will be placed at the step in the new range which equals or exceeds their former salary and will retain their current salary anniversary date. Employees who have been at the top step of the range for more than one year will be placed at the first step in the new range which provides for the equivalent of a one step increase and shall be eligible for additional step increases (if available) after twelve (12) months at the new step. Employees who have been at the top step of the range for less than one (1) year will be eligible for a step increase on their next anniversary date.

**12.6.5 Layoff.** Employees who demote or bump downward in lieu of layoff shall be placed at the highest step in the new range that is equal to or below their former salary. If the former salary exceeds the maximum of the new range, the employee shall be placed at the top step of the new range.

**12.6.6 Recall and Reinstatement.** When an employee is recalled from a layoff list (within 24 months), or reinstated (within twelve (12) months) to his/her former classification, he/she shall be placed in the same step that he/she occupied at the time of separation. The eligibility date for the next increase shall reflect time served toward the next step increase prior to separation, e.g., an employee who terminated or was laid off and had three (3) months to go before the next increase shall have an eligibility date that is three (3) months after recall or reinstatement.

**12.7 Salary Anniversary Dates.** Each employee's anniversary date for step increase purposes shall be established based on the date on which the current step was attained, and the next date shall be based on the required number of months at that step. Anniversary dates shall be adjusted by the full amount of any unpaid leave of absence of fifteen (15) calendar days or longer except as otherwise required by law or this Agreement.

**12.7.1** For employees below the top step in the range, time served toward a step increase shall be credited by retaining the current salary anniversary date except in the following situations:

- a. Promotions resulting in a 10% or more pay increase;
- b. Demotions or downward reclassifications to a step below the top step of the range of the lower classification;
- c. Re-employment.

**12.7.2** In each of the foregoing situations the employee shall receive a new salary anniversary date as of the date of the action and be eligible for a step increase after twelve (12) months provided he/she is below the top step of the range.

12.7.3 Employees who are promoted or reclassified upward and who have been at the top step of their former classification will receive a new anniversary date in all cases where they are placed at a step lower than the top step in a new range.

12.7.4 The following table indicates the effect of these provisions:

Action	Pay Increase	Employees Below Top Step before increase	Employees at Top Step before increase
Promotions and reclasses	Less than 10%	retain SAD	New SAD if below top step in new range
Realignments	lateral exc for top step EE's	retain SAD	If at top step more than 12 mos, 5% increase, new SAD. If less than 12 mos, no increase, retain SAD
Promotions and reclasses	10% or more	new SAD	New SAD if below top step in new range

**12.8 Work Out of Classification.** An employee shall be eligible for work-out-of-classification (WOOC) pay when qualified and assigned to perform the essential functions of a position in a higher classification for one full duty shift or more - eight (8), nine (9) or ten (10) hours - as applicable. For purposes of this Section, “essential functions” of the position are those duties which distinguish the higher level of work. Such assignments must be approved by the Division/Department head or his/her designee. WOOC assignments may be made only to a vacant position (or one which is temporarily vacant by virtue of the absence of the incumbent due to leave or training) or for special assignment.

12.8.1 When assigned to a position within any Clark County Local 17 bargaining unit the employee shall be placed on the lowest step in the new range which results in an increase equivalent to a one step increase, or the first step in the range of the higher classification, whichever is greater.

12.8.2 WOOC assignments to management or unrepresented positions or positions in other than Local 17 bargaining units shall be governed in all respects by County policies or applicable bargaining agreements.

**12.9 Meal Allowances.** Employees shall be eligible for a meal allowance of ten dollars (\$10) after each four (4) consecutive hours of overtime worked contiguously with the regular shift or after eight (8) hours of overtime on a day off.

**12.10 Mileage Reimbursement.** Employees who are required by the County to use their personal vehicles for County business shall be reimbursed for work related mileage. The reimbursement rates shall be the IRS optional standard mileage rate allowance. The Finance Director shall periodically publish the reimbursement rate or as specified in appendices to this

Agreement. The County's Business Expense Reimbursement Policy follows the IRS guidelines for mileage reimbursement.

**12.11 Payroll** Employees shall be paid on the 10th and 25th of each month, reflecting actual hours worked and leave taken/earned for the preceding half month work period (1st to 15th and 16th to end of month). If payday falls on a Saturday, Sunday or holiday, paychecks shall be issued on the previous workday.

**12.12 Overpayments and Underpayments.**

12.12.1 The County shall correct the pay rate or amount of any form of compensation or benefit found to have been overpaid or underpaid. Underpayments by the County shall be paid to the employee in a single payment as soon as practicable.

12.12.2 Employees are legally required to return overpayments to the County. The repayments must be made by payroll deduction in order to correct and adjust the necessary tax payment and adjustments.

12.12.3 The following steps will be undertaken:

12.12.3.1 The County and employee will agree on a repayment schedule so as to not cause an undue burden on the employee. In most cases the repayment will occur over the same or fewer pay periods that the overpayment occurred. For example, an employee repaying the County for overpayment that occurred over six pay periods would be entitled to repay the funds over six pay periods. Employees are required to consent to the payroll deductions necessary to effect such repayments.

12.12.3.2 If agreement on a repayment schedule can not be reached, the County may initiate a deduction not to exceed five (5) percent of the employee's disposable earnings in a pay period other than the final pay period. The deduction shall continue until the overpayment is fully recouped.

12.12.4 Any outstanding overpayment that exists at the time of termination will be withheld from the final paycheck.

12.12.5 An employee may request a union representative attend any meeting scheduled to discuss the overpayment and repayment options.

12.12.6 Employees who receive excess compensation are expected to report the error to the County. Employees who knew or should have known of an overpayment and fail to report the matter are subject to appropriate corrective action.

**12.12 Shift Differential.** Employees whose regularly scheduled shift begins after 2:00 PM will receive a shift differential of \$1.25 per hour. Such differential shall be paid on all hours worked on the shift plus observed holidays. It shall be included in payments for paid leave per Section 12.2.2. Short-term assignments to other shifts of one week or less or assignments made to accommodate an employee's personal situation do not qualify for shift differential.

## ARTICLE 13. VACATION

**13.1 Accrual Basis.** Employees who are not on the Paid Time Off (PTO) plan shall accrue vacation based on the schedule below. Vacation accrual will be pro-rated based on the number of hours in paid status and no accrual shall occur during unpaid leave. Regular part-time employees shall accrue vacation on a pro rata basis. New employees shall accrue vacation beginning with the first day of employment but shall not be eligible to sell back or receive termination payoff until completion of six (6) months of service. New employees are generally not authorized use of vacation in the first six (6) months of employment but exceptions may be authorized by the department head or elected official.

### 13.2 Accrual Rates.

13.2.1 Regular full-time employees shall accrue vacation according to the following schedule:

Completed Years of Service	Hours per pay period	Hours per Year	Days per Year	Max
Start	3.33	80	10	NA
1	4.33	104	13	208
5	5.33	128	16	256
10	6.33	152	19	304
15	7.33	176	22	352
20	8.33	200	25	400
25	9.33	224	28	448
30	10.33	248	31	496

13.2.2 Bargaining unit employees hired prior to January 1, 1984, shall continue to earn vacation on the following schedule until the above schedule provides a higher accrual rate.

Hours per Pay Period	Hours per Year	Days per Year	Max
9	216	27	432

**13.3 Maximum Accumulations.** Employees may accumulate vacation up to a maximum of two (2) times their annual accrual rate, e.g., an employee earning 21 days/168 hours may not accumulate more than 42 days/336 hours. When an employee has reached the maximum allowable accrual, future accruals will cease until such time as the balance allows for additional earnings. Employees are responsible for monitoring their accruals and scheduling time off as necessary to preserve the ability to accrue vacation.

**13.4 Vacation Scheduling.** Employee requests for vacation leave shall normally be granted, provided the requested time off would not interfere with workload requirements and schedules.

13.4.1 Black out dates for vacation scheduling will be permitted for unusual departmental situations. In such circumstances the department will first meet the Union through labor management and the Union will have input on the proposed black out schedule.

**13.5 Termination Payoff.** Upon termination of County employment with more than six (6) months of service an employee shall be paid for all accrued and unused vacation and comp-time at his or her final base hourly rate of pay. The termination payoff shall be based on the hourly rate of pay as of the last day of work. Employees may not elect to extend employment beyond the last day of work by using accumulated leave.

**13.6 Vacation Leave Donation Plan.** Employees may donate vacation to the sick leave account of another employee for the employee or for a covered family member suffering from an extended serious illness or injury as provided for by current County policy. Leave amounts shall be calculated based on the donor's hourly rate and credited to the receiving employee based on his/her hourly rate. The County shall, in its sole discretion, determine the eligibility of the employee or covered family member to receive donations and the means for apportionment of donated leave. Such determination shall be based on the severity of the illness or injury, length of service and the employee's performance and attendance record.

**13.7 Vacation Sell-Back.** Employees may elect pay in lieu of vacation up to a maximum of sixty (60) hours per year. Vacation sell-back is subject to the following requirements and procedures:

13.7.1 The opportunity to cash out vacation shall be offered twice per year in the months of June and December. Requests must be submitted by May 15 and November 15 on forms designated by the payroll office.

13.7.2 To be eligible to cash out vacation, an employee must have used a total of eighty (80) hours vacation and floating holiday hours in the prior calendar year. The total of vacation sold may not exceed the maximum hours limitation but may be apportioned according to the employee's choice between the June and December sales periods.

13.7.3 Vacation sales may be restricted or suspended by the County. In the event vacation sales requests exceed available funds, the Human Resources Department shall develop procedures to equitably apportion vacation sales among employees with pending requests.

**13.8** Effective January 1, 2013 employees may voluntarily opt to switch to an alternative leave system for Paid Time Off (PTO) in accordance with Appendix E to this Agreement (this plan combines vacation time, sick leave and floating holiday accruals). Once the election is made, it is irrevocable.

13.8.1 Effective January 1, 2013 new employees hired into the County shall be placed in the Paid Time Off (PTO) leave system in accordance with Appendix E to this Agreement.



## ARTICLE 14. HOLIDAYS

**14.1 Observed Holidays.** The following days are recognized as legal paid holidays for which time off is to be granted:

New Year's Day – January 1<sup>st</sup>  
Martin Luther King's Birthday – Third Monday in January  
Presidents' Day – Third Monday in February  
Memorial Day – Last Monday in May  
Independence Day – July 4<sup>th</sup>  
Labor Day – First Monday in September  
Veterans' Day – November 11<sup>th</sup>  
Thanksgiving Day – Fourth Thursday in November  
The day immediately following Thanksgiving Day  
Christmas Day – December 25<sup>th</sup>

14.1.1 Any of the above holidays which fall on a Saturday shall be observed on the previous Friday. Any of the above holidays which fall on a Sunday shall be observed on the following Monday.

14.1.2 Employees shall receive the same number of holidays regardless of work schedule. If the date of observance of a holiday falls on an employee's day off, the employee shall receive an alternative day off or be paid for the holiday. To be eligible for pay for a holiday, the employee must be in paid status on the scheduled workdays immediately before and after the holiday. Employees will not receive pay for holidays occurring during an unpaid leave of absence or after the last day of work in the case of termination. The first day of work for a new employee may not be the day of a holiday.

14.1.3 Holidays occurring during a period of leave with pay (vacation, sick leave, or other paid leave) shall be charged as a paid holiday leave and shall not be charged against paid leave.

**14.2 Floating Holidays.** Employees shall receive two (2) floating holidays per year. Floating holidays shall be credited on January 1st of each year.

14.2.1 Floating holidays must be used by the end of the year and may not be carried forward into the next calendar year.

14.2.2 Requests for use of floating holidays may be in increments of one-half (1/2) hour. Requests should comply with procedures outlined for the use of vacation except that departments may authorize shorter advance request requirements or less formal application procedures.

14.2.3 New employees shall receive a pro rata share of floating holiday hours at the rate of one twelfth of the annual entitlement for each full month of service during the year. Employees who terminate during the year shall be entitled to cash out unused floating holiday hours based on the foregoing formula.

14.2.4 Employees who are in the Paid Time Off (PTO) leave system shall not accrue floating holidays and shall have such leave in accordance with Appendix E to this agreement.

**14.3 Part Time and Variable Schedule Employees.** Part-time employees shall be credited with observed and floating holidays on a pro rata basis based upon the ratio of their assigned schedule to full-time employment.

14.3.1 Employees working a full time but irregular schedule such as a 4-10 or other alternative work schedule arrangement shall receive eight (8) hours of holiday leave for each observed or floating holiday. Full pay for the period may be obtained by charging additional leave, e.g. a 4-10 employee can use eight (8) hours of regular holiday time and two (2) hours of floating holiday time to receive full pay for a holiday falling on the day of a ten (10) hour shift or may take it as unpaid leave. To the extent that it is compatible with the business needs of the county, and with approval of department management, full pay for the period may be obtained by permitting employees to flex their schedules to “make up” the hours to a maximum of forty (40) hours per work week (overtime will not result from hours worked to earn the “make up” holiday hours). Employees must notify their supervisor at least two (2) weeks in advance of their desire to flex their schedule during a work week in which a holiday falls.

**14.4 Holiday Work Premium.** Regular full-time and regular part-time employees who are required to work on a holiday shall be compensated in pay or compensatory time off at the rate of time and one half for all hours worked. Individual employees who work on both the legal holiday and the day of its observance will receive the holiday work premium on either day but not both. As with overtime, the choice of compensatory time off requires approval of the employee and the department.

**14.5 Commissioners Holiday.** The special Commissioners Holiday may be granted or not granted at the sole discretion of the Board of County Commissioners and the hours, rules and procedures governing its use are not subject to any duty to bargain or the grievance procedure of this Agreement.

## ARTICLE 15. SICK LEAVE

**15.1 Purpose.** Sick leave is provided to continue pay during illness or injury incapacitating the employee to perform his/her work, contagious disease whereby his/her attendance at work would create a direct threat to the health of fellow employees or the public, or as otherwise provided by law or this Article. The County and the Union agree that sick leave use is subject to certain conditions and restrictions as defined herein.

15.1.1 Employees who are in the Paid Time Off (PTO) leave system shall not accrue sick leave and shall have such leave in accordance with Appendix E to this Agreement.

15.1.2 Use of sick leave is contingent upon following required reporting procedures and compliance with the purposes of sick leave. Employees who fail to call in according to procedures or fail to provide medical verification, if properly requested, may be charged unpaid time for the absence.

15.1.3 With management approval, earned vacation leave or accrued compensatory time may be used when accrued sick leave is not available for an absence necessitated by illness or injury.

**15.2 Sick Leave Accruals.** Full time employees covered by this Article shall accrue sick leave at the rate of eight (8) hours per month or ninety-six (96) hours per year. Sick leave may be accumulated up to a maximum of twelve hundred (1200) hours.

15.2.1 Employees shall accrue sick leave based on paid hours. For example, an employee earning twelve (12) days per year shall accrue .0461538 hours (96/2080) for each straight time hour of work or paid leave.

15.2.2 No accrual shall occur during unpaid leave and sick leave accrual will be pro-rated based on the number of hours in paid status up to a maximum of the employee's full or part time schedule. Regular part-time employees shall accrue sick leave on a pro rata basis.

**15.3 Workers' Compensation Integration.** An employee may charge his/her sick leave account, or other accrued paid leave if his/her sick leave balance is exhausted for the difference between any compensation received from the Workers' Compensation Insurance and the employees' normal pay for injuries or illnesses covered by Workers' Compensation. The calculation shall be based on the difference between the employee's pay period compensation (rate time pay period hours) minus the benefits from Workers' Compensation. Employees may use accrued sick leave or other accrued leave for the first three day waiting period for Time Loss benefits.

**15.4 Family Illness Usage.** Except as provided in Article 10.3.2 employees may use sick leave in the event of an illness or injury in the employee's immediate family requiring the attendance of the employee. For the purposes of this Section, immediate family is defined as spouse, domestic partner subject to state law and County policy, dependent children incapable of self care of the employee or their domestic partner provided the child resides in the home of the

employee and the domestic partner, parents or the step/in-law equivalents and grandparents. Sick and/or unpaid leave may be allowed to care for such other relatives and in such circumstances as required by state and federal leave laws and administrative regulations.

**15.5 Medical and Dental Appointments.** Except as provided in Article 10.3.2, sick leave will be allowed for doctor and dentist appointments for the employee or members of the employee's immediate family requiring the attendance of the employee. If the employee has used all sick leave, use of other accrued paid leave will be allowed. Employees shall make a reasonable effort to schedule these appointments to occur during off-duty hours or during the work day such that it causes the least disruption to the department.

**15.6 Reporting and Approval Procedure.** Employees unable to report for duty shall notify the employer's designated representative in accordance with procedures and timelines established at the department level. Employees who know in advance that they will be utilizing sick leave for a particular purpose (e.g., surgery, hospitalization, dental or medical appointments, etc.) shall give notice of the dates of such leave as far in advance of the leave as is practicable, but employees shall take into consideration department needs and recognize that under normal circumstances a twenty-four (24) hour notification is reasonable. Employees who fail to notify the department of an absence are subject to disciplinary action for absence without leave.

**15.7 Medical Verification.** The Employer may require a physician's certification of the nature and duration of an employee's disability from work, of an employee's ability to return to work, and/or of an employee's ability to continue the full performance of his or her duties.

**15.8 Attendance.** The parties agree that employee attendance is an important element of overall job performance, contribution to the organization and service to the community.

15.8.1 The parties also agree that the effective management of employee attendance should incorporate the following overall principles:

- Management is responsible for taking appropriate, corrective action when attendance falls below expectations (including progressive discipline as outlined in Article 19.2.)
- Employees are responsible for addressing the circumstances which give rise to absences.
- Time off taken under the auspices of federal and state disability and family leave laws will not be considered as part of an assessment of employee attendance or a corrective action plan.

15.8.2 For the purposes of this Section, "attendance" refers only to absences due to illness or injury and not to scheduled absences such as vacation, comp-time, floating holidays, bereavement leave, military leave, PTO system leave, industrial injury leave and jury duty.

**15.9 Sick Leave Payoff.** Employees who separate from County service via resignation or layoff with at least ten (10) years of service will be paid for accrued but unused sick leave at their base rate of pay according to the following formula:

Portion/tier of Accumulated hours	Percent payable	Maximum payout
900 to 1,200	75% of hours over 899	225
600 to 899	50% of hours over 599	150
300 to 599	25% of hours over 299	75
Total		450

For example, an employee earning fourteen dollars (\$14.00) per hour with a balance of twelve hundred (1200) hours would be paid for seventy-five percent (75%) of the top bank of three hundred (300) hours ( $1200-900 \times 75\% = 225$  hours), 50% of the next bank of three hundred (300) hours ( $900-600 \times 50\% = 150$  hours) and twenty five (25%) of the next bank ( $600-300 \times 25\% = 75$  hours) for a total of four hundred and fifty (450) hours or sixty-three hundred dollars (\$6,300.00) Employees with balances below three hundred (300)hours are not eligible for payoff.

## ARTICLE 16. OTHER LEAVES

**16.1 Bereavement and Funeral Leave.** A regular employee shall be granted up to three workdays (maximum of 24 hours) of paid bereavement leave at the time of a death in the employee's immediate family. Such employee shall be granted up to an additional two days (maximum of 16 hours) of paid bereavement leave when air travel or one-way land travel of four hours or longer is necessary. To be eligible for the additional one or two days (maximum 8 or 16 hours) paid leave, pre-authorization from the Department Director or designate is required. Bereavement leave shall be prorated based on FTE, and may be used consecutively or non-consecutively. Bereavement leave shall normally be used within two weeks of the date of the death. Exceptions to the two-week use provision will be considered on a case by case basis and requires manager approval.

Bereavement leave may be used for qualifying family members in the case of imminent death but the total bereavement leave portion shall not exceed the three or five workday (maximum 40 hour) limitation. For the purposes of this Section, eligible family members are:

- a. the spouse, children, parents, brother, sister (or the step and in-law equivalents)
- b. the employee's grandparents, grandchildren, aunts and uncles
- c. the employee's domestic partner and children, parents, brother, sister (or the step and in-law equivalents) of the domestic partner (an Affidavit of Domestic Partnership must be on file in the HR-Benefits Department).
- d. other relatives living in the employee's household.

16.1.1 Bereavement leave in excess of the durations identified above or for other relatives may be granted with the approval of the supervisor and charged to an employee's vacation, floating holiday, or compensatory time account.

16.1.2 Time off with pay for no more than three hours of bereavement leave will be allowed for attending the funeral of a County employee.

**16.2 Military Leave.** The County shall abide by the provisions of Federal and State laws to provide military leave and reinstatement rights for employees. The provisions of the laws are defined under the Uniformed Services Employment and Reemployment Rights Act (USERRA), and Washington State Law RCW 38.40.060. Employee benefits will only continue for those months in which the employee is in a paid status the first working day of the month.

### **16.3 Civic Duty and Examination Leave.**

16.3.1 Leave with pay shall be granted as necessary to allow employees to serve as a member of a jury. Any compensation received by the employee for such duties, excluding mileage allowance and meal allowance, shall be waived, remitted to the County, or, in the alternative, the County shall pay the difference between the employee's regular salary and the fees received. When an employee is excused or dismissed from

jury duty, he/she shall promptly notify the Employer. Employees may be required to report to work for any portion of their regularly scheduled shift during which they are not actually serving on a jury or waiting to be assigned to a panel of jurors.

16.3.2 Service as a witness in matters arising from the course and scope of employment shall be considered on-duty time. Service as a witness or party to non job related matters shall be charged against the employee's vacation, floating holiday or comp time balance or may be taken as unpaid leave at the option of the employee.

16.3.3 Upon prior notice to his/her supervisor, an employee shall be allowed paid work time to take examinations required for other positions within the County. Testing undertaken on a day off shall not be considered working hours for overtime calculation purposes.

16.3.4 Employees unable to vote while off duty may use paid vacation, comp time or floating holiday time to vote.

**16.4 Serious Health Conditions, FMLA and Family Care Leave.** The employer shall authorize leaves of absences to employees for qualifying circumstances, as specified in the Federal Family and Medical Leave Act (FMLA), the Washington Family Leave Law, the Family Care Act, this Agreement and other relevant statutes.

**16.4.1 Reporting Requirements.** Employees unable to report for duty shall notify the employer's designated representative in accordance with procedures and timelines established at the department level. The employees requesting leave for a qualifying circumstance under this article must state why they are off work, the expected duration of the time off of work, and if the leave is to care for a family member the employee must identify which family member. In situations where an emergency arises the employee must notify the designated representative as soon as reasonably possible under the circumstances. For Family Care Leave the employee should provide as much advance notice of the need as possible. For FMLA leave, where possible, an employee should give thirty (30) calendar days advance notice of the need for leave; if thirty (30) calendar days advance notice is not possible the employee or the employee's designee shall request leave as soon as the employee knows of the need to be a way from work.

**16.4.2 Family Care Leave.** Regular and part-time employees, who have accrued paid leave available and have a dependent covered under the Act with a qualified health condition, shall be eligible for Family Care Leave. An eligible employee is entitled to use accrued sick leave or other accrued paid time including Comp Time to care for a legal spouse, parent, parent-in-law, or grandparent of the employee who has a serious health condition or emergency condition, or to care for a child of the employee with a health condition that requires treatment or supervision if the child is either under eighteen years of age or older but incapable of self-care because of mental or physical disability. Family Care Act leave that also qualifies for FMLA and/or the Washington Family Leave Law shall be counted concurrently. The duration of leave under the Family Care Act will continue as long as the employee has accrued paid time available and the family member has a qualified health condition.

**16.4.3 Family Medical Leave.** An FMLA eligible employee may take up to twelve (12) weeks of job protected leave from work because of a serious health condition, a family member's serious health condition, or for parental leave to care for a new born or newly adopted or placed child. Under FMLA, a family member is an employee's parent or person who acted as a parent, legal spouse, or a child who is either under age eighteen (18) or older and incapable of self-care because of a mental or physical disability. Unpaid leave shall be authorized only after the exhaustion of all other available paid leaves including Comp Time. At the time of initial placement, parents of adopted children may use sick leave to care for the child under the same conditions granted natural parents. A birth mother's period of temporary pregnancy related disability shall not be deducted from the twelve (12) week FMLA leave entitlement. All other paid time including Comp Time used during FMLA leave shall be deducted from the twelve (12) week leave entitlement.

16.4.3.1 With agreement of the department, employees may work a reduced work schedule for up to two (2) months preceding and/or following the period of parental leave.

16.4.4 The County may require a physician's certification of the nature and duration of an employee's disability from work, of an employee's ability to return to work, and/or of an employee's ability to continue the full performance of the employee's duties.

**16.5 Workers' Compensation.** All employees are covered by the Washington State Workers' Compensation Act for injuries or illnesses received while at work for the County. An employee may charge his/her sick leave account, or other accrued paid leave if his/her sick leave balance is exhausted, for the difference between any compensation received from the Workers' Compensation Insurance and the employees' normal pay for injuries or illnesses covered by Workers' Compensation. The calculation shall be based on the difference between the employee's pay period compensation (rate times pay period hours) minus the benefits from Workers' Compensation. Employees may use accrued sick leave or other accrued leave for the first three day waiting period for Time Loss benefits.

**16.6 Other Leaves of Absence.** Employees may request leaves of absence of up to twelve (12) months for educational reasons, union business leave, medical/disability leave or compelling personal circumstances. A minimum of two (2) years service is required prior to requesting educational or personal leaves.

16.6.1 All requests for leaves of absence or extensions shall be submitted in writing to the department head or his/her designee and approved in advance of the effective date. Employees reporting to work at the end of an authorized leave of absence shall be employed in the same class held at the start of such leave of absence.

16.6.2 For unpaid leaves of fifteen (15) calendar days or more, salary anniversary and seniority shall be adjusted by the full amount of the unpaid leave. Absence without leave and failure to return from leave shall be treated as job abandonment or may be the basis for termination.



16.6.3 Paid leave taken prior to going on unpaid leave shall not be counted toward the twelve (12) month maximum. Unless otherwise authorized by the department head or applicable elected official and Human Resources, the employee must exhaust accumulated vacation, floating holidays and comp time before going on unpaid status.

**16.7 Mandatory Leave.** The department may place an employee on an appropriate category of leave if it can be reasonably concluded that he/she cannot be permitted to work without risk to the health and safety of the employee, coworkers or the public.

## ARTICLE 17. INSURANCE

**17.1** The Multi-party Healthcare Committee will function under the provisions of the Memorandum of Understanding (Appendix D) and will make decisions regarding healthcare expenditures, and plans for medical and dental insurances for the plan years covered by this agreement.

**17.2 Eligibility.** The County agrees to make available to eligible employees and their dependents one medical/dental plan. An employee may not be insured simultaneously as both an employee and as a dependent and dependents may be insured by only one employee.

17.2.1 Employees shall be eligible for medical insurance effective the first of the month following date of hire as long as the enrollment forms are received within thirty one (31) calendar days from the date coverage is effective. Coverage will terminate at the end of the last day of the month in which employment ends, except as provided in 17.8.

17.2.2 Dental coverage will begin the first of the month following ninety (90) calendar days of employment. Coverage will terminate at the end of the last day of the month in which employment ends, excepted as provided in 17.8.

17.2.3 Part-time employees whose regular schedule calls for thirty (30) hours per week (.75 FTE) or more shall be eligible for the full County contribution.

17.2.3.1 Part-time employees whose regular schedule calls for 20 – 29 (.5 - .749 FTE) hours per week shall be eligible for seventy percent (70%) of the County's contribution for the medical plan and dental plan selected by the employee. The employee shall contribute the amount above the county contribution. The effective date for changes in this section 17.2.3.1 is 1/1/2014.

17.2.3.2 Temporary changes in work hours will not result in a change in benefits available or employer contribution, unless the change in hours continues for three (3) consecutive months or more and then the change will be effective the first of the fourth consecutive month. When the temporary change is anticipated to last longer than three (3) months, the change will become effective immediately on the first of the following month.

17.2.4 Project employees shall be eligible for the medical and dental plans and contributions shall be determined in the same manner as regular employees.

17.2.5 Eligible dependents include legal spouse, domestic partner, and dependent children including the domestic partner's children who reside in the home up to age 19 or until age 23 if a full-time student at an accredited school (unless otherwise required by federal or state law). Employees adding a Domestic Partner must submit the required documentation to HR-Benefits.

17.2.6 Qualified Family Status Changes: Enrollment changes as a result of a qualified family status change will be provided in accordance with state or federal laws and

County policy. Enrollment changes must be received by the County with the applicable documentation within thirty-one (31) calendar days [sixty (60) calendar days for newborns or children placed with the employee for adoption] and shall be effective the first of the month following the date of the qualifying event; except in the case of newborns and adoptions, coverage is effective on the date of birth or placement in the home. Enrollment changes must be received by the County with the applicable documentation within thirty-one (31) calendar days [sixty (60) calendar days for newborns or children placed for adoption] otherwise coverage cannot be obtained until the next open enrollment with coverage effective January 1 of the following year.

**17.2.7 Eligibility for coverage during unpaid leave.** Employees will have continuous coverage during an unpaid leave of absence if covered by federal or state leave laws. For other unpaid leaves, any month in which the employee is in an unpaid status the first of the month and the unpaid leave has been thirty-one (31) continuous calendar days or longer, benefits will not be provided. Coverage will be reinstated effective the first of the month following the date of the employee's return to work; except for return from USERRA leaves and other applicable state and federal protected leaves.

**17.2.8** For Recalled employees (within a twelve month period) and employees returning from furlough, coverage is reinstated the first of the month following the date of re-employment.

**17.2.9 Job Share Benefits.** Job share benefits will be provided to employees sharing the regular work hours and benefits of one full-time position and the employee must work a minimum of 20 hours per week to be eligible for medical, dental, life and disability insurance.

17.2.9.1 Each employee will have the option to enroll in a medical plan and dental plan of the employee's choice. The County contribution for each job-share employee shall be equivalent to 50% of the employer contribution for the medical plan and dental plan selected by the employee. Any premium over the employer contribution will be the responsibility of the employee, or

17.2.9.2 Job-share partners may elect to have one partner have medical coverage only and one have dental coverage only. With this election the county will pay the employer contribution for the coverage in the same manner as a full time employee.

17.2.9.3 Each job share employee shall also receive a life insurance benefit at the same level as provided to full time employees.

**17.2.10** The County will make available medical and dental insurance coverage for the eligible employee's domestic partner subject to required tax regulations relevant to this benefit. To access this benefit, the employee must have a completed Affidavit of Domestic Partnership on file in the HR-Benefits Department.

### **17.3 Premiums.**

17.3.1 Premiums, plans, and cost distribution will be determined through the multi-party Healthcare Committee process as outlined on the Memorandum of Understanding included as Appendix D.

17.3.2 Waiver of Health Insurance (medical and dental). Employees may waive health insurance coverage and receive cash in lieu of coverage as follows:

17.3.2.1 Medical Coverage with proof of other group medical coverage. Full-time employees (30+ hours or more per week) receive \$130 per month (\$65 per pay period); part-time employees (20 – 29 hours per week) receive \$91 per month (\$45.50 per pay period); job-share employees receive \$65 per month (\$32.50 per pay period) if both job-share partners waive coverage.

17.3.2.2 Dental Coverage – proof of other coverage not required. Full-time employees receive \$20 per month (\$10 per pay period); part-time employees receive \$14 per month (\$7 per pay period); and job-share employees receive \$10 per month (\$5 per pay period) if both job-share partners waive coverage.

17.3.2.3 Health Savings Account Contribution. Beginning 2014, employees who voluntarily enroll in the High Deductible Health Plan (HDHP) and Health Savings Account (HAS) shall receive a pay period contribution of \$20.83 for single coverage or \$41.67 for family coverage.

**17.4 Other than Medical and Dental Carrier and Coverage Changes.** The County retains the exclusive right to select plans and carriers for life insurance, long-term disability, or other employer-provided benefits provided that the successor plan(s) shall provide substantially equal or better coverage than the existing plans. This section is not intended to apply to medical or dental plans, which are addressed in the Healthcare Committee Memorandum of Understanding.

**17.5 Open Enrollment.** The County agrees to provide annual open enrollment periods annually and/or beginning not less than thirty (30) days prior to any change in medical coverage. Such open enrollment periods shall be not less than two (2) weeks in duration.

**17.6 Life Insurance.** The County shall provide each employee a group term life insurance policy including accidental death and dismemberment coverage in the amount of \$25,000. Employee and/or dependent coverage shall be made available for employee purchase.

17.6.1 The County shall continue to make available through payroll deduction voluntary supplemental and dependent life insurance to employees, subject to individual evidence of insurability at such premium rates as are established by the carriers. The County will make every effort to negotiate the most effective rates.

**17.7 Long Term Disability Insurance.** The County shall provide each employee long-term disability insurance policy providing for pay continuation of 60% of salary with a sixty (60) day elimination period and such other provisions as are provided by the plan document. Employees may also elect to purchase additional coverage under the Long Term Disability (LTD) Buy-Up plan and will be eligible to receive 66 2/3 % of their covered salary. Benefits are paid up to a

maximum covered salary of fifteen thousand dollars (\$15,000) per month, (e.g. 60% of \$7,500 mo. Salary is \$4,500).

## **17.8 Continuation of Benefits.**

17.8.1 Pursuant to federal or state law, Clark County employees and/or dependents that lose group health care coverage are eligible to continue participation in the group health plan for the time periods as defined in the law. The affected employee and/or dependent are responsible for the cost of the coverage plus an administrative fee, if applicable.

17.8.2 County provided health benefits will continue during an unpaid family and medical leave or accident or illness covered by Workers' Compensation at the same level and under the same conditions as if the employee had continued to work. If the employee chooses not to return to work following an approved family and medical leave for reasons other than a continued serious health condition, the employee will be required to reimburse the County the amount if paid for the employee's health insurance premiums.

17.8.3 Medical and dental insurance will be continued for a period of up to six (6) months when an employee has a disabling condition and qualifies for Long Term Disability benefits at the same level and under the same conditions as if the employee had continued to work. This provision will provide coverage after the employee has exhausted other programs for continued coverage such as Family Medical Leave.

17.8.4 Eligibility for insurance coverage for medical and dental insurance during other unpaid leaves will be in accordance with the federal COBRA program. Employees are not eligible for other insurance coverage during unpaid leaves of absence.

## ARTICLE 18. OTHER BENEFITS

**18.1 Retirement Plan.** The County participates in the Washington State Department of Retirement System. The County and employees are required to contribute a percentage of compensable earnings as set by the State Legislature.

**18.2 Deferred Compensation Plans.** The County agrees to provide opportunities for employees to participate in Internal Revenue Code Section 457 Deferred Compensation Plans. Contributions may be up to the allowable IRS maximum.

**18.3 Flexible Spending Accounts.** The County agrees to make available Dependent Care and Health Care Flexible Spending Accounts as long as allowed under federal law.

**18.4 Employee Assistance Program.** The County agrees to make available an employee assistance program providing confidential counseling services to employees and their eligible dependents.

**18.5 Tuition Reimbursement.** The County shall reimburse an employee for the cost of tuition, registration, associated books and fees for any classes, seminars or conferences taken by an employee on the employee's own time which are directly related to the employee's current position and which, in the opinion of the employer, will result in improved job performance. Prior approval from the Department Head and Human Resources is required and is subject to the availability of budgeted funds. For courses or training for which a grade is issued, the employee must attain a grade of "C" or better in order to receive reimbursement.

**18.6 Parking.** The County Campus Parking Management Plan represents the guidelines for parking within the downtown campus. Except as indicated herein, this Plan applies in its entirety. Exceptions to this plan are as noted below:

- a. Employees will be allowed replacement permit without charge if the need is due to no fault of the employee.
- b. Replacement permits will cost \$5.00 per replacement.

Employees choosing to park in downtown campus, County-provided parking lots shall pay a monthly fee as shown in the schedule below labeled Current Fee. The County may increase the fee(s) up to the Maximum Fee over the life of the Agreement and the County agrees to provide a minimum of thirty-day notice prior to increasing the fee (s). The new Maximum Fee is shown below.

Category of Parking	Current Fee	Maximum Fee
General Access	\$22.00	\$23.00
Uncovered Reserved	\$38.50	\$40.25
Covered Reserved	\$55.00	\$57.50

18.6.1 As part of the County's Commute Trip Reduction efforts, the County will reimburse employees who commute via bus to and from work, an amount equal to the monthly C-Zone pass for the term of this Agreement.

### **18.7 License and Certifications.**

18.7.1 The County shall reimburse or otherwise pay the cost of licenses or certifications which are required to maintain employment in the current classification or required to qualify for promotion to the next level in an alternately staffed job family, e.g. Real Property Appraiser I to II or Engineering Technician Assistant to Technician. This shall include cases where new requirements are established.

18.7.2 Costs for licenses or certificates that are 1) required to qualify for entry into the classification (meaning the employee must possess them to be hired), 2) desired or required for promotion to non-alternately staffed positions or 3) not viewed as cost-justified by the department, are the responsibility of the employee.

18.7.3 The appendices to this Agreement may categorize specific licensing and certification programs as they relate to this Section.

**18.8 Dues and memberships.** Funding for or reimbursement of dues and membership shall be at the discretion of department heads and elected officials or as outlined in appendices to this Agreement.

## **ARTICLE 19. DISCIPLINE AND TERMINATION**

### **19.1 Probationary Periods.**

19.1.1 See Appendices A and B for length of probationary periods upon hire and promotion.

19.1.2 The County may discipline or discharge an employee at any time during an initial probationary period, with or without cause, and such discipline or discharge shall not be subject to appeal. Employees who fail a promotional probationary period shall be returned to their former classification, position and salary step.

**19.2 Disciplinary Actions.** Regular employees may be disciplined in the form of an oral warning, written warning, suspension, demotion or discharge for just cause except that oral warnings are not grievable. The County may document oral warnings but such documentation shall not be included in the employee's personnel file. Grievances concerning written warnings may not be processed beyond Step 3 (Human Resources Director as the Board's designee for Labor Relations).

19.2.1 In the case of a suspension, demotion or discharge, the employee shall be provided a letter setting forth the reason(s) for such action and shall be entitled to respond to the reasons or recommended discipline before such action is taken. Employees are entitled to Union representation at such meetings.

19.2.2 Employees shall be given copies of all disciplinary letters or performance evaluations before placement of such material into their personnel file and will be required to acknowledge receipt in writing. The employee's signature shall not be construed as agreement or concurrence with the discipline or evaluation. Copies of written reprimands and any other disciplinary letters will be provided to the Union.

**19.3 Disciplinary Investigations and Meetings.** In disciplinary investigations, an employee shall be afforded all Constitutional rights customarily associated with the Weingarten and Loudermill cases. If an employee is suspended prior to or during an investigation, they shall be in a pay status pending outcome of the investigation and/or disciplinary action. Employees shall be advised of their right to Union representation during any investigatory interview or meeting which could reasonably be expected to lead to disciplinary action. Union representation is not required at non-investigatory meetings such as those conducted to notify the employee of disciplinary action being taken or imposed.

**19.4 Personnel Files.** Disciplinary materials at the level of a written warning or higher shall be maintained in the official personnel file of the employee. Access to personnel files shall be limited to the employee, his/her authorized representative, officials of the County who have a business need for the access or as required by public records and freedom of information laws at the federal or state level. Employees shall have the right to review their files after providing reasonable advance notice and shall have the right to attach reasonable materials in explanation of or rebuttal to adverse materials. Adverse materials shall not be placed in the personnel file



without the knowledge of the employee. Written warnings shall be removed after two (2) years if there are no related problems.

## **19.5 Voluntary Termination Procedure.**

19.5.1 **Resignation.** Any employee desiring to terminate employment with the County in good standing shall present a letter of resignation at least two (2) calendar weeks prior to the effective date of termination. The date of resignation shall be the last day of work and leave payoffs shall be based on balances as of the date of termination. The letter of resignation shall indicate the effective date and the reason for the resignation. Employees who quit without adequate notice may be ineligible for future employment with the County. The Appointing Authority may waive the two (2) week notification period.

19.5.2 **Retirement.** Employees who intend to retire should provide a minimum of thirty (30) days written notice of retirement date.

### **19.5.3 Abandonment of Position.**

19.5.3.1 An employee shall be considered to have resigned via abandonment of his/her position based on any of the following circumstances:

- a. absence for three (3) consecutive days without notice or approval;
- b. failure to return from a leave of absence following the last day of approved leave after three (3) consecutive days without notice or approval.

19.5.3.2 Employees considered to have abandoned their positions will be terminated and the separation will be treated as a resignation without notice. In the event it was not the employee's intention to resign, absence without leave constitutes an adequate basis for discipline and an employee may be involuntarily terminated for action constituting abandonment of the position unless the failure to notify was clearly beyond the employee's control. The appointing authority will send a confirming notice to employees considered to have abandoned their positions.

19.5.3.3 In the event a grievance concerning abandonment is pursued to arbitration, the arbitrator's authority shall be limited to determining whether this Section was properly applied.

**19.6 Indemnification.** Clark County shall protect, defend, hold harmless and indemnify for any damages, including court ordered attorney's fees, all covered employees and their respective marital communities against any and all claims or causes of action which arise as a result of alleged acts or errors and omission occurring within the scope of their duties and responsibilities or employment with Clark County. The County may elect not to provide indemnification for acts not undertaken in good faith, acts of misconduct or if the employee fails to fully cooperate with the defense of such action. Legal representation services will be provided by the Prosecuting Attorney's Office or outside counsel at the discretion of the County.

## ARTICLE 20. GRIEVANCE PROCEDURE

### 20.1 Purpose and Scope.

20.1.1 The purpose of this Grievance Procedure is to establish effective machinery for the fair, expeditious and orderly adjustment of grievances. Only matters involving the interpretation, application, enforcement or alleged violation of an express provision of this Agreement and appendices shall constitute a grievance.

20.1.2 The parties agree that every effort should be made to resolve grievances informally with the first level supervisor or others, as appropriate, and to settle grievances at the lowest possible level. The grievant and/or the Union and the appropriate employer representative shall meet, if necessary, to attempt to resolve the grievance at any step.

20.1.3 A grievance may move to any level in the grievance procedure by written mutual agreement of the parties.

**20.2 Filing and Processing Requirements.** A grievance may be brought under this procedure by one or more aggrieved employees, with or without a Union representative, or by the Union as a class grievance (hereafter described as "the grievant"). No grievance shall be processed beyond Step 3 without Union concurrence and representation.

20.2.1 Disciplinary grievances shall be initially submitted at Step 2. Grievances concerning written warnings may not be processed beyond Step 3.

20.2.2 Class or class action grievances of bargaining unit wide application shall be initially submitted at Step 3. Class grievances are those which would potentially have application across departmental lines and/or apply to a large number of employees covered by this Agreement, for example, interpretation of overtime work periods.

20.2.3 A written grievance shall be signed and dated and indicate the step at which is being filed. Grievances not meeting the requirements of this Section shall not be considered officially filed or may not be moved to the next step until the missing information is provided, as applicable. Written grievances and responses shall address, at a minimum, the following points:

- a. The statement of the grievance/response and the facts upon which it is based;
- b. A statement of the specific provision(s) of the Agreement that is (are) the basis of the grievance/response;
- c. The manner in which the provision is purported to have been violated, misapplied or misinterpreted (or in which the provision supports the response);

- d. The date or dates on which the alleged violation, misinterpretation or misapplication occurred; and
- e. The specific remedy sought or offered.

### **20.3 Timelines.**

20.3.1 When computing deadlines under this Article, the day which triggers the deadline (contract violation, receipt of grievance, etc.) shall not be included. "Working days" means Monday through Friday, excluding holidays. Filing and response time limits shall be met by mailing, e-mail, delivery or facsimile transmission. Receipt shall be considered to be the date of actual receipt. The time limits prescribed herein may be waived or extended by mutual agreement, in writing, by the aggrieved employee, or the Union in a class grievance, and the appropriate Employer representative at each step.

20.3.2 A grievance not brought within the time limit prescribed for every step shall be considered settled on the basis of the last decision received by the grievant or the Union. A grievance or complaint not responded to by the Employer representative may be moved to the next step in the procedure.

### **20.4 Steps.**

20.4.1 **Step 1.** If unable to resolve the grievance informally with the immediate supervisor, the grievant shall present the grievance in writing to his/her immediate manager (defined as the first level of management not included in the bargaining unit or as otherwise designated by the department head or elected official). The grievance must be filed within ten (10) working days of the occurrence of the grievance or the date the grievant knew or should have known of its occurrence or the date of conclusion of informal resolution attempts. Copies of the grievance shall be filed with the department head or elected official and Human Resources. The immediate manager must respond in writing within ten (10) working days.

20.4.2 **Step 2.** If the grievance is not resolved at Step 1, the aggrieved employee or the Union shall submit the written grievance to the department head or elected official within ten (10) working days, following the manager's response. The department head or elected official shall respond in writing to this grievance within ten (10) working days.

20.4.3 **Step 3.** If the grievance is not resolved at Step 2, the employee or Union shall submit the written grievance to the Human Resources Director as the Board's designee for Labor Relations within ten (10) working days of receipt of the department head or elected official's response. The Human Resources Director shall respond in writing to this grievance within ten (10) working days.

20.4.4 **Step 4.** If the grievance has not been resolved, the Union may refer the dispute to final and binding arbitration. The Union shall notify the County in writing, of submission to arbitration within ten (10) working days after receipt of the Employer's written response in Step 3 above.

20.4.5 The above steps shall include meetings between the parties at the request of either party to facilitate resolution of the grievance.

**20.5** The Union and the County shall endeavor to mutually agree upon an arbitrator. If a mutually acceptable arbitrator cannot be determined, the Union requesting arbitration shall request a list of eleven (11) qualified neutrals (or as many as are available) from the Federal Mediation and Conciliation Service (FMCS) who shall reside in Oregon and Washington and be members of the National Academy of Arbitrators. Each party shall have the right to reject one panel in its entirety and request that a new panel be submitted. Within ten (10) working days after receipt of the list, the parties shall alternately strike the names on the list, and the remaining name shall be the arbitrator. The first strike shall be made by the Union. As an alternative to requesting lists and striking names, the Union and the County may agree to use the services of a particular arbitrator.

**20.6** The arbitrator shall have the power to issue and enforce subpoenas in accordance with Chapter 7.04 RCW. The arbitrator shall not have the power to add to, subtract from, or modify the provisions of this Agreement in arriving at a decision of the issue or issues presented, and shall confine his/her decision solely to the interpretation, application, or enforcement of this Agreement. The arbitrator shall confine him/herself to the issues submitted for arbitration, and shall have no authority to determine any other issues not so submitted to him/her. The decision of the arbitrator shall be submitted within thirty (30) days and shall be final and binding upon the employees, Union and employer. The arbitrator's decision shall be in writing and within the scope and terms of this Agreement.

**20.7** Each party shall be responsible for compensating its own representatives and witnesses. If either party desires a verbatim transcript of the proceedings, it shall pay the costs of the court reporter and of the arbitrator's copy of the transcript. Should both parties desire a copy of the transcript, they shall share the costs of the court reporter and of the arbitrator's copy of the transcript. The losing party shall bear the fees and expenses of the arbitrator.

**20.8** It is agreed that the grievance procedure is intended to be the exclusive remedy for resolving contractual disputes that may arise out of the interpretation or application of this collective bargaining agreement and that taking an issue to arbitration shall constitute a waiver of the right of the Union to litigate the subject matter in any other forum. However, this Agreement shall not constitute a waiver of the right to the individual employee to litigate the subject matter in any other form.

**20.9 Mediation.** As an alternative or supplement to the grievance procedure, or for such other purposes as the parties may mutually determine, the parties may invoke a mediation process to resolve grievances or other issues between them as provided herein. As contemplated by this Section, mediation involves the use of a third party, to serve as a mediator, using contemporary mediation techniques. A decision to utilize a mediator shall be voluntary by both parties and subject to the following understandings:

20.9.1 The mediator shall be a mutually acceptable PERC staff representative, or in the alternative, the parties may share equally the cost of employing a fee-based professional

mediator. The parties may choose to strike names from a list, employ a standing panel or select on a case-by-case basis.

20.9.2 If the parties agree to enter into mediation, the mediator shall attempt to assist the parties in achieving a voluntary resolution. The mediator will not have the authority to force either party to accept a particular resolution. If the parties are unable to reach **resolution**, the mediator, **if the parties mutually agree**, may be requested to offer a bench opinion.

20.9.3 Settlement discussions by the parties during mediation may not be introduced during any subsequent arbitration or PERC proceedings, nor may the comments by the mediator be referenced.

## ARTICLE 21. DEFINITIONS

**Absence without Leave** or Absence without approval or implied consent. Consent may be implied when the employee follows management's established practice for requesting leave.

**Demotion** - Appointment of an employee to a job classification with a lower maximum top step salary.

**Full Time or Full Time Employee** - A normal work schedule of forty (40) hours per week on a continuing basis.

**Higher Classification** - A classification with a higher maximum base wage rate.

**Homogeneous Classification Series** – A classification series, or job family, consisting of related job functions and multiple pay levels with increasing tasks, complexity and independence. The Appraisers Unit consists of two (2) job families. One job family contains the following titles: Industrial Appraiser, Commercial Appraiser Specialist, Appraisal Systems Analyst, Current Use Appraiser, Sales Analyst Statistician and Real Property Appraiser I-IV. The second job family includes the Personal Property Appraiser II-IV. For the Purposes of the Engineers bargaining unit the homogeneous job families include: Engineer III to Engineer II/I, Senior Engineering Technician to Engineering Technician or Assistant, Engineering Technician to Engineering Assistant. Employees having completed the probationary period in any one of the job family levels are considered to have completed the probationary period in any of the lower level classifications in the family.

**Lateral Classification** - A classification with an identical maximum base wage rate.

**Lateral Transfer** - Appointment to a position in a lateral classification or between positions in the same classification.

**Lower Classification** - A classification with a lower maximum base wage rate.

**Part-Time** - A normal work schedule of fewer than forty (40) hours per week.

**Promotion** - Appointment of an employee to a position in a higher classification with a higher maximum top step of base wage rate.

**Realignment** - An adjustment to the salary range of an entire classification

**Recall** - The reappointment of a laid off employee from a recall list following layoff or the offering of a position through the recall procedure.

**Reclassification** - A change of a regular budgeted position from one job classification to another (including new classifications) and/or the resulting action on the incumbent employee. (As distinguished from promotion when an employee promotes from one existing position to another existing position).

- a. Reclassification of a job may be appropriate when the duties, responsibilities, scope of work and other job factors change to such an extent that the classification to which it had been assigned no longer adequately describes the work. Changes to a job not warranting a reclassification include increased volume of the same level work, duties not previously assigned but within the same classification, enhanced technological tools to perform current duties, or longevity.
- b. Changes to jobs which may necessitate changes in classification can occur instantly, such as when there is a planned reorganization within a work unit or department or over time from gradual changes in the scope of duties or authority of a position.

**Reemployment** - The rehire of a regular employee after more than one (1) year of separation or to a classification other than that from which the employee terminated. Employees may only be reemployed by applying through normal competitive selection processes however employees who return to county employment within two (2) years of separation shall be entitled to bridge their service for vacation accrual purposes only.

**Reinstatement** - The rehire of an employee in his/her former classification pursuant to Article 9.4.11 of this Agreement within one (1) year of termination.

**Rehire** – The return to employment with Clark County through reemployment, reinstatement, or by appointment of a laid off employee to a vacant position for which they are qualified but have no recall rights based on the following:

- a. **Reemployment** – The rehire of a regular employee after more than one (1) year of separation or to a classification other than that from which the employee terminated. Employees may only be reemployed by applying through normal competitive selection processes. However employees who return to County employment with two (2) years of separation shall be entitled to bridge their service for vacation accrual purposes only.
- b. **Reinstatement** – The rehire of an employee in his/her former classification pursuant to Article 9.4.11 of this Agreement within one (1) of termination.

**Regular Employee** - An employee who is in a regular budgeted position.

**Salary** - The employee's rate of pay, whether expressed as an hourly or monthly figure. (See Article 12 for computation and discussion of hourly versus salaried treatment).

**Salary Anniversary Date or Review Date** - The date as specified by this Agreement upon which an employee is eligible for a step increase within his/her range.

**Service or Continuous Service** - An employee's length of continuous employment with the County since his/her most recent date of hire as a full-time or part-time employee in a regular budgeted position. Seniority may be defined based on time in the County, Department, bargaining unit or job classification as provided by this Agreement.



**Temporary Employee** - An employee hired on a limited term basis.

**Vacant and Available Positions** - Those regular and funded positions which management has determined will be filled.

## **ARTICLE 22. SUBSTANCE ABUSE FREE WORKPLACE**

**22.1 Statement of Principle.** The County and the Union, in keeping with the provisions of the Drug-Free Workplace Act of 1988, are committed to providing and maintaining a substance abuse-free working environment for the safety, physical and mental health of all employees and the public whom we serve.

Any unlawful manufacture, distribution, dispensation, possession, use or working under the influence of an illegal drug or controlled substance in or on any County facility, vehicle or while on County business is strictly prohibited. Consumption of alcohol is prohibited for employees while on duty (including any breaks, lunches, etc.) or while in a designated "on-call" status or two (2) hours following an accident or incident (unless a breath alcohol test has already been performed).

Clark County has established a drug awareness program which includes, but is not limited to, the following confidential employee services:

1. Drug counseling and rehabilitation available through the County's medical insurance plans
2. Employee Assistance Program (EAP) that may assist in counseling employees with substance/alcohol abuse problems
3. Clark County Dept. of Community Services: Alcohol and Drug Services Program

Any employee found to be in violation of the County's Substance Abuse Free Workplace Policy will be subject to a requirement to participate satisfactorily in an abuse assistance or rehabilitation program approved for such purposes by a federal, state, local health, or appropriate agency approved by Clark County, and/or appropriate disciplinary action up to and including termination.

**22.2 Covered Classifications.** All classifications within the Union bargaining unit are covered by this article.

### **22.3 Drug or Alcohol Tests Required.**

**22.3.1 Post Incident.** To be conducted after accidents and/or incidents involving an employee and/or equipment and/or facility. Post incident testing shall take place as soon as practicable, but no later than within two (2) hours following the accident or incident for alcohol and within thirty-two (32) hours of the accident or incident for drugs. An employee subject to such testing is expected to remain readily available to undergo the tests. However, this should not be construed to require the delay of necessary medical attention for injuries or to prohibit an employee from leaving the scene of an accident or incident if necessary to obtain assistance to respond to the accident or incident or to obtain emergency medical care. In all circumstances the testing will be conducted at the job site, collector's office or medical facility (transportation, if necessary, will be

provided). An employee waiting to be tested will remain in paid status from the time of the accident/incident until testing is completed.

Employees who test negative will be transported back to the duty station and remain on paid status for the completion of the shift or if normal work hours are exceeded, until leaving the normal place of work. Employees whose tests are not immediately available will be transported from the test site to their residence via a local cab company at the County's expense, or provided the opportunity to contact a non-duty-employee or non-employee for a ride. Employees, who leave the scene of an accident or incident inappropriately, will be considered to have refused to test and will be subject to corrective disciplinary action up to and including termination.

**22.3.2 Non-DOT post-incident/accident testing.** In the event an employee (s) accident/incident results in significant property damage in excess of \$2,500 to county or private party property, and management determines that a post-incident non-DOT drug and alcohol test is warranted, an on-site rapid drug test providing instant results will be administered in addition to the breath alcohol test. Employee(s) tested will be allowed to remain actively at work as regularly scheduled if the rapid drug and breath alcohol test results are negative. Positive rapid test results requiring additional lab testing and confirmation will be handled in accordance with the remainder of Article 22.

**22.3.3 Reasonable Suspicion.** Conducted when a supervisor observes specific indicators characteristic of prohibited drug or alcohol use is present in the employee's appearance, behavior, speech or body. The supervisor will request a second opinion from another non-represented management employee who has been trained (both must agree) prior to requesting an employee to take a reasonable suspicion drug/alcohol test. At this time, the employee shall be informed of the right to Union representation. This will not be construed as an opportunity for an employee to delay testing. Employees may not operate county motor vehicles or equipment after being notified that a reasonable suspicion test is warranted. Additionally, employees believed to be under the influence or impaired for any reason shall be tested at the job site, collector's office or medical facility (transportation, if necessary, will be provided). Following the testing, the employee will be transported home via a local cab company, at the County's expense, or provided the opportunity to contact a non-duty-employee or non employee for a ride. The employee will be informed that the law enforcement authorities shall be notified of his/her vehicle license number if the employee insists on driving. In no case will a supervisor or other on-duty employee transport the employee.

**22.3.4 Refusal to Test.** Refusing or failing to submit an adequate specimen for drug or alcohol testing or specimen tampering during specimen collection, as defined by the Medical Review Officer (MRO), will be treated as if the employee has tested positive. The employee will be evaluated by a Substance Abuse Professional (SAP) or Chemical Dependency Professional (CDP) and will be subject to discipline up to and including immediate termination.

22.3.5 Refusal to submit to a test includes:

- Refusal to take a drug or alcohol test
- Tampering with or attempting to adulterate the specimen or collection procedure
- Not reporting to the collection site in the time allotted, or
- Leaving the scene of an accident or incident without a valid reason before testing.

22.3.6 **Providing False Information.** Any employee providing false information will be treated as if they have tested positive, be evaluated by a SAP or CDP, and will be subject to discipline up to and including immediate termination.

**22.4 Drug/Alcohol Testing Processes.** Drug and alcohol testing shall be conducted in strict accordance with federal regulations to ensure accuracy, reliability, and confidentiality. Testing records and results will be released only to those authorized by the federal drug and alcohol testing rules to receive such information. Clark County will make every appropriate effort to protect the employee's privacy and dignity during the sample collection, testing and notification process.

22.4.1 **Drug Testing.** Specimen collection for drug testing will conform to controlled certified laboratory standards to maintain documented chain of custody and assure sample reliability. Testing for drugs will be conducted at the job site, collector's office or medical facility. The specific procedure used for testing is as follows:

- The collection site personnel will obtain the appropriate urine custody and control forms and inspect the collection room.
- The donor will be asked to present picture identification to the collection site person.
- The donor will check belongings and remove unnecessary outer garments.
- Donor will wash hands, take the collection cup and enter the privacy enclosure to collect at least forty-five (45) milliliters of specimen unobserved.
- The collection site person records the temperature of the specimen.
- The specimen will be split into two bottles.
- Both bottles will be labeled and sealed in front of the donor.
- The custody control form will be completed, transferring custody from the donor to the collection site person.
- The split specimen will be placed in secure storage until shipped for analysis.

The integrity of the testing process is ensured through a variety of methods. The collection site is secured when not in use, access to the site is restricted during specimen collection, water sources are controlled to discourage specimen adulteration, trained site collection personnel carefully follow prescribed procedures, specimens are labeled and sealed in front of the donor, chain of custody forms are used, specimens are left in locked storage, and the laboratories used for analysis must meet strict standards to be certified by the U.S. Department of Health and Human Services.

The initial drug screen shall use the Immunoassay process and the confirmatory test will be by gas chromatography/mass spectrometry. The drug testing results will be reviewed and positive tests interpreted by the MRO. The following tests and positive test levels shall be used:

Initial test analyte	Initial test cutoff concentration	Confirmatory test analyte	Confirmatory test cutoff concentration
Marijuana metabolites.....	50 g/mL.....	THCA <sup>1</sup> .....	15 ng/mL
Cocaine etabolites.....	150 /mL.....	Benzoylcgonine.....	100 ng/mL
Opiate metabolites			
Codeine/Morphine <sup>2</sup> .....	2000 ng/mL.....	Codeine .....	2000 ng/mL
		Morphine.....	2000 ng/mL
6–Acetylmorphine.....	10 ng/mL.....	6–Acetylmorphine.....	10 ng/mL
Phencyclidine.....	25 ng/mL.....	Phencyclidine.....	25 ng/mL
Amphetamines <sup>3</sup>			
AMP/MAMP <sup>4</sup> .....	500 ng/mL.....	Amphetamine.....	250 ng/mL
		Methamphetamine <sup>5</sup> .....	250 ng/mL
MDMA <sup>6</sup> .....	500 ng/mL.....	MDMA.....	250 ng/mL
		MDA <sup>7</sup> .....	250 ng/mL
		MDEA <sup>8</sup> .....	250 ng/mL

<sup>1</sup> Delta-9-tetrahydrocannabinol-9-carboxylic acid (THCA).

<sup>2</sup> Morphine is the target analyte for codeine/morphine testing.

<sup>3</sup> Either a single initial test kit or multiple initial test kits may be used provided the single test kit detects each target analyte independently at the specified cutoff.

<sup>4</sup> Methamphetamine is the target analyte for amphetamine/methamphetamine testing.

<sup>5</sup> To be reported positive for methamphetamine, a specimen must also contain amphetamine at a concentration equal to or greater than 100 ng/mL.

<sup>6</sup> Methylenedioxymethamphetamine (MDMA).

<sup>7</sup> Methylenedioxyamphetamine (MDA).

<sup>8</sup> Methylenedioxyethylamphetamine (MDEA).

**22.4.2 Alcohol Testing.** The alcohol test will be performed using an Evidential Breath Testing (EBT) device that is approved by the National Highway Traffic Safety Administration (NHTSA) and administered by a trained Breath Alcohol Technician (BAT).

The alcohol testing process will consist of the following steps:

- Upon arrival, the employee will be shown to the testing site. The site will afford the employee privacy during the process.
- The employee will provide picture identification to the BAT for inspection.
- The BAT will explain the test process and will, with the employee, complete the Alcohol Testing Form.
- The BAT will open a sealed disposable mouthpiece in view of the employee and attach it to the EBT device for a screening test.
- The employee will blow forcefully into the mouthpiece and be shown the result.

- If the test result is less than .04 (non-DOT and .02 (DOT)) the test will be recorded as negative.
- If the initial test indicates an alcohol concentration of .04 (non-DOT and .02 (DOT) or greater, a second confirmatory test will be conducted at least 15 minutes, but not more than 30 minutes, after the initial test.
- Before the confirmatory test is conducted, the BAT shall conduct an airblank test which must read 0.00 to proceed.
- The confirmatory test will be conducted using the same screening procedures as the screening test with the exception of the post-test airblank.
- If the test results are not identical, the result of the confirmatory test is considered to be the final result.

The integrity of the alcohol testing process is ensured through the external calibration checks required on the EBT device, the security of the testing site and EBT device, and the strict testing procedures required to produce a valid test.

### **22.5 Positive Test Results.**

An employee who tested .04 or greater for alcohol or fails to pass a drug test will be removed from the performance of his/her job, and evaluated by a substance abuse professional. An employee may substitute any available vacation, floating holiday or comp time for the non-pay status.

An employee who tests positive for illegal drugs or controlled substances will be removed from the performance of his/her job, and evaluated by a Substance Abuse Professional (SAP) or Chemical Dependency Professional (CDP).

An employee who tests positive for drugs shall have the right to challenge the accuracy of the test results. The employee may request that the original sample be analyzed again. Such request must be made within 72 hours of when the MRO made the employee aware of the original test results.

### **22.6 Pay Status.**

If an employee is removed from his/her job prior to or during an investigation, they shall be in a pay status pending outcome of the investigation and/or disciplinary action. Employees shall be advised of their right to union representation during any investigatory interview or meeting which could reasonably be expected to lead to disciplinary action.

Employees who have satisfied any disciplinary action and who are in a recognized treatment program for a drug or alcohol problem may use available sick leave, floating holiday, accrued vacation or comp time for counseling and treatment.

### **22.7 Return to Duty and Follow-up Testing.**

An employee who tests positive for an illegal drug, controlled substance and/or alcohol will generally be allowed to return to duty following compliance with all treatment recommendations

of the SAP or CDP. Employees who test positive a second time for an illegal drug, controlled substance or alcohol or who fail to comply with treatment requirements (as determined by the SAP or CDP) are subject to immediate termination.

Follow up testing will be conducted when an individual who has violated the prohibited substance abuse conduct standards returns to work. Follow-up tests are unannounced and will be conducted as recommended by the SAP or CDP. Follow-up testing of CDL drivers must conform to DOT standards. Employees testing positive during the follow-up testing period are subject to discipline up to and including immediate termination.

## **22.8 Employee Rights and Responsibilities.**

The County will keep confidential all testing results.

If at any point the results of the testing procedures specified in Section 22.4 (Drug & Alcohol Testing Processes) of this Article are negative, all further testing shall be discontinued. The employee will be provided a copy of the results, and all other copies of the results (including the original) will be maintained in the Human Resources Department.

Prior to participating in the mandatory testing process, employees who voluntarily seek assistance concerning a drug or alcohol problem shall not be disciplined by the employer and will be immediately referred to the County's EAP. Employees may use available sick leave, floating holiday, accrued vacation or comp time for counseling and treatment.

An employee not designated "on-call" and requested to report to work shall inform their supervisor of any inability to work due to the consumption of alcohol or drugs which may impair the employee's ability to safely perform his/her job. Under this Section, an employee will not be subject to discipline for advising the employee's supervisor of his/her inability to work.

All employees who must use a prescription drug that causes or results in adverse side effects (e.g., drowsiness or impaired reflexes or reaction time) shall inform their supervisor that they are taking such medication according to the advice of a physician. Employees are not required to notify their supervisor of the name of the medication, only that they are taking a medication that causes adverse side effects. If the prescription drug use could cause productivity or safety problems, a supervisor may grant the employee sick leave or temporarily assign the employee different duties, if available.

Employees are required, in compliance with this Substance Abuse Free Workplace Policy, to notify the County of any criminal statute conviction for a substance abuse related violation occurring in the workplace no later than five (5) working days after such conviction.

## **22.9 Education and Training.**

All supervisors and first level managers will be required to attend a training course which will cover this policy, the effects of illegal drugs, controlled substances and/or alcohol abuse in the workplace, behavioral symptoms of being under the influence of drugs and alcohol, and rehabilitation services available. Union shop stewards will be invited to attend the above training. Employees attending the training will be on paid status. Refresher courses will be offered periodically and will also be on paid status.

All employees will receive a copy of this Section, informational materials about the effects of controlled substances/alcohol in the workplace and rehabilitation services available.

## **22.10 Record Retention.**

The drug and alcohol records will be maintained in the Human Resources department in a secure location with controlled access, in accordance with HIPAA guidelines. The following records shall be maintained for five (5) years:

- Records of alcohol test results indicating an alcohol concentration of .04 or greater.
- Records of verified positive drug test results.
- Documentation of refusal to take a required alcohol/drug tests.
- Drug and Alcohol related evaluations and referrals.

Records of negative and canceled drug tests and alcohol test results with a concentration of less than .04 shall be expunged immediately unless following a valid positive test and in that case subject to the same retention as the positive test.

The County shall provide copies of these records to other employers when former County employees have applied for employment with those employers and have written and signed a release form authorizing the County to release such information.

## **22.11 Laws & Regulations**

Should the federal or state government requirements change, the parties agree to negotiate the impact of the change on mandatory subjects of bargaining.



## **ARTICLE 23. SCOPE AND DURATION**

**23.1 Entire Agreement.** This Agreement and its Appendices constitute the entire Agreement between the parties and concludes collective bargaining for its term subject only to a desire by both parties to mutually agree to amend or supplement at any time. The County and the Union hereby voluntarily and unqualifiedly waive the right, and each agrees that the other shall not be obligated, to bargain collectively with respect to any subject matter referred to or covered by this Agreement. With respect to subjects not covered by this Agreement, the parties agree that the County may temporarily implement changes pending the outcome of any bargaining required by RCW 41.56.

**23.2 Savings Clause.** Should any article, section, or portion thereof, of this Agreement be held unlawful and unenforceable, such decision shall apply only to the specific article, section, or portion thereof directly affected. The parties agree to immediately negotiate a substitute, if possible, for the invalidated article, section or portion thereof. All other portions of this Agreement, and the Agreement as a whole, shall continue without interruption for the term hereof.

**23.3 Duration and Renewal.** The parties agree that all provisions of this Agreement and its appendices shall be effective on the first day of the second month following signing except for those provisions which have a specific effective date in the Agreement. It shall remain in full force and effect through the 30th day of June 2015

23.3.1 The County and the Union agree to begin negotiations no later than April 30, 2015 and will continue to negotiate through August 31, 2015. Any/all unresolved matters will then either be withdrawn by the respective party or be referred to the PERC sponsored mediation.

# APPROVAL

This Agreement entered into between Clark County and the Professional and Technical Employees, Local 17 was formally signed and approved on the \_\_31st\_\_ day of December, 2012.

## BOARD OF CLARK COUNTY COMMISSIONERS

  
Marc Boldt, Chair

### FOR THE COUNTY

  
Francine M. Reis,  
Human Resources Director

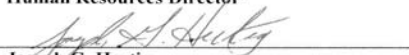
  
Joseph G. Hertig  
Human Resources Manager

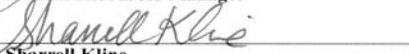
  
Sharrell Kline  
Human Resources Manager

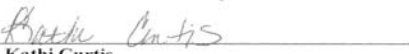
  
Kathi Curtis  
Senior Human Resources Representative

  
Peggy Muhly  
Employee Relations Manager

  
Matt Hall  
Engineering Services Manager

  
Cindy Steinbarger  
DES Solid Waste Program Coordinator II

  
Ron Wieranga  
DES Clean Water Program Manager III

### LOCAL 17 PROFESSIONAL & TECHNICAL EMPLOYEES

  
Joseph L. McGee  
Executive Director

  
Roberta Burnett  
Union Representative

  
Pam Mason  
Engineers Bargaining Committee

  
Ron Kerlin  
Engineers Bargaining Committee

  
Cary Armstrong  
Engineering Bargaining Committee

  
Mary Howells  
Appraisers Bargaining Committee

  
Carla Simmons  
Appraisers Bargaining Committee

  
Carla R. Sims

### ASSESSORS OFFICE

  
Linda M. Latta  
Chief Deputy Assessor

  
Dennis G. Scholtz  
Program Manager

## EXHIBIT A

2013 1.75% Increase (effective 12/1/2012, new steps effective 1/1/2013)													
Table	Rg.	Title	1	2	3	4	5	6	7	8	9	10	11
AP	250	Real Property Appraiser I	16.37	16.75	17.12	17.58	18.03	18.48	18.92	19.39	19.87	20.36	20.85
AP	253	Personal Prop Auditor App II	18.92	19.39	19.87	20.36	20.85	21.40	21.95	22.48	23.01	23.60	24.18
AP	253	Real Property Appraiser II	18.92	19.39	19.87	20.36	20.85	21.40	21.95	22.48	23.01	23.60	24.18
AP	256	Real Property Appraiser III	21.95	22.48	23.01	23.60	24.18	24.78	25.38	26.01	26.63	27.30	27.96
AP	257	Personal Prop Auditor App III	23.01	23.60	24.18	24.78	25.38	26.01	26.63	27.30	27.96	28.66	29.35
AP	257	Sales Analyst Statistician	23.01	23.60	24.18	24.78	25.38	26.01	26.63	27.30	27.96	28.66	29.35
AP	259	Appraisal Systems Analyst	25.38	26.01	26.63	27.30	27.96	28.66	29.35	30.10	30.84	31.60	32.36
AP	259	Current Use Appraiser	25.38	26.01	26.63	27.30	27.96	28.66	29.35	30.10	30.84	31.60	32.36
AP	259	Personal Prop Auditor App IV	25.38	26.01	26.63	27.30	27.96	28.66	29.35	30.10	30.84	31.60	32.36
AP	259	Real Property Appraiser IV	25.38	26.01	26.63	27.30	27.96	28.66	29.35	30.10	30.84	31.60	32.36
AP	260	Commercial Appraiser Spec.	26.63	27.30	27.96	28.66	29.35	30.10	30.84	31.60	32.36	33.16	33.96
AP	261	Industrial Appraiser	27.96	28.66	29.35	30.10	30.84	31.60	32.36	33.16	33.96	34.83	35.68
EN	200	Real Property Assistant	16.85	17.27	17.67	18.12	18.57	19.03	19.49	19.97	20.46	20.97	21.48
EN	204	Engineering Technician, Ass't	19.99	20.48	20.96	21.48	22.00	22.57	23.13	23.71	24.29	24.90	25.51
EN	205	Real Property Agent I	20.96	21.48	22.00	22.57	23.13	23.71	24.29	24.90	25.51	26.39	27.27
EN	207	Design Drafter	23.13	23.71	24.29	24.90	25.51	26.14	26.76	27.43	28.10	28.82	29.52
EN	207	Engineer I	23.13	23.71	24.29	24.90	25.51	26.14	26.76	27.43	28.10	28.82	29.52
EN	207	Engineering Technician	23.13	23.71	24.29	24.90	25.51	26.14	26.76	27.43	28.10	28.82	29.52
EN	207	Traffic Signal Technician	23.13	23.71	24.29	24.90	25.51	26.14	26.76	27.43	28.10	28.82	29.52
EN	207A	Engineering Technician - Cert Prem	24.29	24.90	25.51	26.14	26.76	27.43	28.10	28.81	29.52	30.24	30.96
EN	207A	Engineering Technician - Chief of Party	24.29	24.90	25.51	26.14	26.76	27.43	28.10	28.81	29.52	30.24	30.96
EN	208	Capital Prog Specialist	24.29	24.90	25.51	26.14	26.76	27.43	28.10	28.82	29.52	30.24	30.96
EN	208	Capital Project Manager I	24.29	24.90	25.51	26.14	26.76	27.43	28.10	28.82	29.52	30.24	30.96
EN	208	Real Property Agent II	24.29	24.90	25.51	26.14	26.76	27.43	28.10	28.82	29.52	30.24	30.96
EN	210	Engineer II	26.76	27.43	28.10	28.82	29.52	30.24	30.96	31.76	32.55	33.36	34.17
EN	210	Engineering Technician, Sr.	26.76	27.43	28.10	28.82	29.52	30.24	30.96	31.76	32.55	33.36	34.17
EN	210	Real Property Agent III	26.76	27.43	28.10	28.82	29.52	30.24	30.96	31.76	32.55	33.36	34.17
EN	210	Sustainability Specialist	26.76	27.43	28.10	28.82	29.52	30.24	30.96	31.76	32.55	33.36	34.17
EN	210	Traffic Signal Technician, Sr	26.76	27.43	28.10	28.82	29.52	30.24	30.96	31.76	32.55	33.36	34.17
EN	211	Capital Prog Specialist, Sr	28.10	28.82	29.52	30.24	30.96	31.76	32.55	33.36	34.17	35.02	35.87
EN	211	Capital Project Manager II	28.10	28.82	29.52	30.24	30.96	31.76	32.55	33.36	34.17	35.02	35.87
EN	213	Engineer III	30.96	31.76	32.55	33.36	34.17	35.02	35.87	36.76	37.66	38.61	39.57
EN	214	Capital Project Manager III	32.55	33.36	34.17	35.02	35.87	36.76	37.66	38.61	39.57	40.56	41.53
EN	214	Traffic Engineer	32.55	33.36	34.17	35.02	35.87	36.76	37.66	38.61	39.57	40.56	41.53

Highlighted Columns are Former Steps 1-6

2014 2.00% Increase (effective 1/1/2014)													
Table	Rg.	Title	1	2	3	4	5	6	7	8	9	10	11
AP	250	Real Property Appraiser I	16.70	17.09	17.46	17.93	18.39	18.85	19.30	19.78	20.27	20.77	21.27
AP	253	Personal Prop Auditor App II	19.30	19.78	20.27	20.77	21.27	21.83	22.39	22.93	23.47	24.07	24.66
AP	253	Real Property Appraiser II	19.30	19.78	20.27	20.77	21.27	21.83	22.39	22.93	23.47	24.07	24.66
AP	256	Real Property Appraiser III	22.39	22.93	23.47	24.07	24.66	25.28	25.89	26.53	27.16	27.85	28.52
AP	257	Personal Prop Auditor App III	23.47	24.07	24.66	25.28	25.89	26.53	27.16	27.85	28.52	29.23	29.94
AP	257	Sales Analyst Statistician	23.47	24.07	24.66	25.28	25.89	26.53	27.16	27.85	28.52	29.23	29.94
AP	259	Appraisal Systems Analyst	25.89	26.53	27.16	27.85	28.52	29.23	29.94	30.70	31.46	32.23	33.01
AP	259	Current Use Appraiser	25.89	26.53	27.16	27.85	28.52	29.23	29.94	30.70	31.46	32.23	33.01
AP	259	Personal Prop Auditor App IV	25.89	26.53	27.16	27.85	28.52	29.23	29.94	30.70	31.46	32.23	33.01
AP	259	Real Property Appraiser IV	25.89	26.53	27.16	27.85	28.52	29.23	29.94	30.70	31.46	32.23	33.01
AP	260	Commercial Appraiser Spec.	27.16	27.85	28.52	29.23	29.94	30.70	31.46	32.23	33.01	33.82	34.64
AP	261	Industrial Appraiser	28.52	29.23	29.94	30.70	31.46	32.23	33.01	33.82	34.64	35.53	36.39
EN	200	Real Property Assistant	17.19	17.62	18.02	18.48	18.94	19.41	19.88	20.37	20.87	21.39	21.91
EN	204	Engineering Technician, Ass't	20.39	20.89	21.38	21.91	22.44	23.02	23.59	24.18	24.78	25.40	26.02
EN	205	Real Property Agent I	21.38	21.91	22.44	23.02	23.59	24.18	24.78	25.40	26.02	26.92	27.82
EN	207	Design Drafter	23.59	24.18	24.78	25.40	26.02	26.66	27.30	27.98	28.66	29.40	30.11
EN	207	Engineer I	23.59	24.18	24.78	25.40	26.02	26.66	27.30	27.98	28.66	29.40	30.11
EN	207	Engineering Technician	23.59	24.18	24.78	25.40	26.02	26.66	27.30	27.98	28.66	29.40	30.11
EN	207	Traffic Signal Technician	23.59	24.18	24.78	25.40	26.02	26.66	27.30	27.98	28.66	29.40	30.11
EN	207A	Engineering Technician - Cert Prem	24.78	25.40	26.02	26.66	27.30	27.98	28.66	29.39	30.11	30.84	31.58
EN	207A	Engineering Technician - Chief of Party	24.78	25.40	26.02	26.66	27.30	27.98	28.66	29.39	30.11	30.84	31.58
EN	208	Capital Prog Specialist	24.78	25.40	26.02	26.66	27.30	27.98	28.66	29.40	30.11	30.84	31.58
EN	208	Capital Project Manager I	24.78	25.40	26.02	26.66	27.30	27.98	28.66	29.40	30.11	30.84	31.58
EN	208	Real Property Agent II	24.78	25.40	26.02	26.66	27.30	27.98	28.66	29.40	30.11	30.84	31.58
EN	210	Engineer II	27.30	27.98	28.66	29.40	30.11	30.84	31.58	32.40	33.20	34.03	34.85
EN	210	Engineering Technician, Sr.	27.30	27.98	28.66	29.40	30.11	30.84	31.58	32.40	33.20	34.03	34.85
EN	210	Real Property Agent III	27.30	27.98	28.66	29.40	30.11	30.84	31.58	32.40	33.20	34.03	34.85
EN	210	Sustainability Specialist	27.30	27.98	28.66	29.40	30.11	30.84	31.58	32.40	33.20	34.03	34.85
EN	210	Traffic Signal Technician, Sr	27.30	27.98	28.66	29.40	30.11	30.84	31.58	32.40	33.20	34.03	34.85
EN	211	Capital Prog Specialist, Sr	28.66	29.40	30.11	30.84	31.58	32.40	33.20	34.03	34.85	35.72	36.59
EN	211	Capital Project Manager II	28.66	29.40	30.11	30.84	31.58	32.40	33.20	34.03	34.85	35.72	36.59
EN	213	Engineer III	31.58	32.40	33.20	34.03	34.85	35.72	36.59	37.50	38.41	39.38	40.36
EN	214	Capital Project Manager III	33.20	34.03	34.85	35.72	36.59	37.50	38.41	39.38	40.36	41.37	42.36
EN	214	Traffic Engineer	33.20	34.03	34.85	35.72	36.59	37.50	38.41	39.38	40.36	41.37	42.36

2015 2.00% Increase (effective 1/1/2015)													
Table	Rg.	Title	1	2	3	4	5	6	7	8	9	10	11
AP	250	Real Property Appraiser I	17.03	17.43	17.81	18.29	18.76	19.23	19.69	20.18	20.68	21.19	21.70
AP	253	Personal Prop Auditor App II	19.69	20.18	20.68	21.19	21.70	22.27	22.84	23.39	23.94	24.55	25.15
AP	253	Real Property Appraiser II	19.69	20.18	20.68	21.19	21.70	22.27	22.84	23.39	23.94	24.55	25.15
AP	256	Real Property Appraiser III	22.84	23.39	23.94	24.55	25.15	25.79	26.41	27.06	27.70	28.41	29.09
AP	257	Personal Prop Auditor App III	23.94	24.55	25.15	25.79	26.41	27.06	27.70	28.41	29.09	29.81	30.54
AP	257	Sales Analyst Statistician	23.94	24.55	25.15	25.79	26.41	27.06	27.70	28.41	29.09	29.81	30.54
AP	259	Appraisal Systems Analyst	26.41	27.06	27.70	28.41	29.09	29.81	30.54	31.31	32.09	32.87	33.67
AP	259	Current Use Appraiser	26.41	27.06	27.70	28.41	29.09	29.81	30.54	31.31	32.09	32.87	33.67
AP	259	Personal Prop Auditor App IV	26.41	27.06	27.70	28.41	29.09	29.81	30.54	31.31	32.09	32.87	33.67
AP	259	Real Property Appraiser IV	26.41	27.06	27.70	28.41	29.09	29.81	30.54	31.31	32.09	32.87	33.67
AP	260	Commercial Appraiser Spec.	27.70	28.41	29.09	29.81	30.54	31.31	32.09	32.87	33.67	34.50	35.33
AP	261	Industrial Appraiser	29.09	29.81	30.54	31.31	32.09	32.87	33.67	34.50	35.33	36.24	37.12
EN	200	Real Property Assistant	17.53	17.97	18.38	18.85	19.32	19.80	20.28	20.78	21.29	21.82	22.35
EN	204	Engineering Technician, Ass't	20.80	21.31	21.81	22.35	22.89	23.48	24.06	24.66	25.28	25.91	26.54
EN	205	Real Property Agent I	21.81	22.35	22.89	23.48	24.06	24.66	25.28	25.91	26.54	27.46	28.38
EN	207	Design Drafter	24.06	24.66	25.28	25.91	26.54	27.19	27.85	28.54	29.23	29.99	30.71
EN	207	Engineer I	24.06	24.66	25.28	25.91	26.54	27.19	27.85	28.54	29.23	29.99	30.71
EN	207	Engineering Technician	24.06	24.66	25.28	25.91	26.54	27.19	27.85	28.54	29.23	29.99	30.71
EN	207	Traffic Signal Technician	24.06	24.66	25.28	25.91	26.54	27.19	27.85	28.54	29.23	29.99	30.71
EN	207A	Engineering Technician - Cert Prem	25.28	25.91	26.54	27.19	27.85	28.54	29.23	29.98	30.71	31.46	32.21
EN	207A	Engineering Technician - Chief of Party	25.28	25.91	26.54	27.19	27.85	28.54	29.23	29.98	30.71	31.46	32.21
EN	208	Capital Prog Specialist	25.28	25.91	26.54	27.19	27.85	28.54	29.23	29.99	30.71	31.46	32.21
EN	208	Capital Project Manager I	25.28	25.91	26.54	27.19	27.85	28.54	29.23	29.99	30.71	31.46	32.21
EN	208	Real Property Agent II	25.28	25.91	26.54	27.19	27.85	28.54	29.23	29.99	30.71	31.46	32.21
EN	210	Engineer II	27.85	28.54	29.23	29.99	30.71	31.46	32.21	33.05	33.86	34.71	35.55
EN	210	Engineering Technician, Sr.	27.85	28.54	29.23	29.99	30.71	31.46	32.21	33.05	33.86	34.71	35.55
EN	210	Real Property Agent III	27.85	28.54	29.23	29.99	30.71	31.46	32.21	33.05	33.86	34.71	35.55
EN	210	Sustainability Specialist	27.85	28.54	29.23	29.99	30.71	31.46	32.21	33.05	33.86	34.71	35.55
EN	210	Traffic Signal Technician, Sr	27.85	28.54	29.23	29.99	30.71	31.46	32.21	33.05	33.86	34.71	35.55
EN	211	Capital Prog Specialist, Sr	29.23	29.99	30.71	31.46	32.21	33.05	33.86	34.71	35.55	36.43	37.32
EN	211	Capital Project Manager II	29.23	29.99	30.71	31.46	32.21	33.05	33.86	34.71	35.55	36.43	37.32
EN	213	Engineer III	32.21	33.05	33.86	34.71	35.55	36.43	37.32	38.25	39.18	40.17	41.17
EN	214	Capital Project Manager III	33.86	34.71	35.55	36.43	37.32	38.25	39.18	40.17	41.17	42.20	43.21
EN	214	Traffic Engineer	33.86	34.71	35.55	36.43	37.32	38.25	39.18	40.17	41.17	42.20	43.21

2015 2.00% Increase (effective 1/1/2015)

Table	Rg.	Title	1	2	3	4	5	6	7	8	9	10	11
AP	250	Real Property Appraiser I	17.03	17.43	17.81	18.29	18.76	19.23	19.69	20.18	20.68	21.19	21.70
AP	253	Personal Prop Auditor App II	19.69	20.18	20.68	21.19	21.70	22.27	22.84	23.39	23.94	24.55	25.15
AP	253	Real Property Appraiser II	19.69	20.18	20.68	21.19	21.70	22.27	22.84	23.39	23.94	24.55	25.15
AP	256	Real Property Appraiser III	22.84	23.39	23.94	24.55	25.15	25.79	26.41	27.06	27.70	28.41	29.09
AP	257	Personal Prop Auditor App III	23.94	24.55	25.15	25.79	26.41	27.06	27.70	28.41	29.09	29.81	30.54
AP	257	Sales Analyst Statistician	23.94	24.55	25.15	25.79	26.41	27.06	27.70	28.41	29.09	29.81	30.54
AP	259	Appraisal Systems Analyst	26.41	27.06	27.70	28.41	29.09	29.81	30.54	31.31	32.09	32.87	33.67
AP	259	Current Use Appraiser	26.41	27.06	27.70	28.41	29.09	29.81	30.54	31.31	32.09	32.87	33.67
AP	259	Personal Prop Auditor App IV	26.41	27.06	27.70	28.41	29.09	29.81	30.54	31.31	32.09	32.87	33.67
AP	259	Real Property Appraiser IV	26.41	27.06	27.70	28.41	29.09	29.81	30.54	31.31	32.09	32.87	33.67
AP	260	Commercial Appraiser Spec.	27.70	28.41	29.09	29.81	30.54	31.31	32.09	32.87	33.67	34.50	35.33
AP	261	Industrial Appraiser	29.09	29.81	30.54	31.31	32.09	32.87	33.67	34.50	35.33	36.24	37.12
EN	200	Real Property Assistant	17.53	17.97	18.38	18.85	19.32	19.80	20.28	20.78	21.29	21.82	22.35
EN	204	Engineering Technician, Ass't	20.80	21.31	21.81	22.35	22.89	23.48	24.06	24.66	25.28	25.91	26.54
EN	205	Real Property Agent I	21.81	22.35	22.89	23.48	24.06	24.66	25.28	25.91	26.54	27.46	28.38
EN	207	Design Drafter	24.06	24.66	25.28	25.91	26.54	27.19	27.85	28.54	29.23	29.99	30.71
EN	207	Engineer I	24.06	24.66	25.28	25.91	26.54	27.19	27.85	28.54	29.23	29.99	30.71
EN	207	Engineering Technician	24.06	24.66	25.28	25.91	26.54	27.19	27.85	28.54	29.23	29.99	30.71
EN	207	Traffic Signal Technician	24.06	24.66	25.28	25.91	26.54	27.19	27.85	28.54	29.23	29.99	30.71
EN	207A	Engineering Technician - Cert Prem	25.28	25.91	26.54	27.19	27.85	28.54	29.23	29.98	30.71	31.46	32.21
EN	207A	Engineering Technician - Chief of Party	25.28	25.91	26.54	27.19	27.85	28.54	29.23	29.98	30.71	31.46	32.21
EN	208	Capital Prog Specialist	25.28	25.91	26.54	27.19	27.85	28.54	29.23	29.99	30.71	31.46	32.21
EN	208	Capital Project Manager I	25.28	25.91	26.54	27.19	27.85	28.54	29.23	29.99	30.71	31.46	32.21
EN	208	Real Property Agent II	25.28	25.91	26.54	27.19	27.85	28.54	29.23	29.99	30.71	31.46	32.21
EN	210	Engineer II	27.85	28.54	29.23	29.99	30.71	31.46	32.21	33.05	33.86	34.71	35.55
EN	210	Engineering Technician, Sr.	27.85	28.54	29.23	29.99	30.71	31.46	32.21	33.05	33.86	34.71	35.55
EN	210	Real Property Agent III	27.85	28.54	29.23	29.99	30.71	31.46	32.21	33.05	33.86	34.71	35.55
EN	210	Sustainability Specialist	27.85	28.54	29.23	29.99	30.71	31.46	32.21	33.05	33.86	34.71	35.55
EN	210	Traffic Signal Technician, Sr	27.85	28.54	29.23	29.99	30.71	31.46	32.21	33.05	33.86	34.71	35.55
EN	211	Capital Prog Specialist, Sr	29.23	29.99	30.71	31.46	32.21	33.05	33.86	34.71	35.55	36.43	37.32
EN	211	Capital Project Manager II	29.23	29.99	30.71	31.46	32.21	33.05	33.86	34.71	35.55	36.43	37.32
EN	212	Utility Coordinator	30.71	31.46	32.21	33.05	33.86	34.71	35.55	36.43	37.32	38.25	39.18
EN	213	Engineer III	32.21	33.05	33.86	34.71	35.55	36.43	37.32	38.25	39.18	40.17	41.17
EN	214	Capital Project Manager III	33.86	34.71	35.55	36.43	37.32	38.25	39.18	40.17	41.17	42.20	43.21
EN	214	Traffic Engineer	33.86	34.71	35.55	36.43	37.32	38.25	39.18	40.17	41.17	42.20	43.21

**APPENDIX A**

**between**

**CLARK COUNTY, WASHINGTON**

**and**

**APPRAISERS AND OTHER PROFESSIONALS UNIT**

**July 1, 2012 - June 30, 2015**

**Appraisers and Other Professionals:** Local 17, Professional and Technical Employees

## APPENDIX A

### APPRAISERS AND OTHER PROFESSIONALS UNIT

The bargaining unit covered by this Appendix is Appraisers and Other Professionals and is defined as all regular full time and regular part-time employees in the classifications listed below and represented by Professional and Technical Employees, Local 17.

#### COVERED CLASSIFICATIONS

<u>Title</u>	<u>Range</u>
Real Property Appraiser I	250
Personal Property Auditor Appraiser II	253
Real Property Appraiser II	253
Real Property Appraiser III	256
Personal Property Auditor Appraiser III	257
Sales Analyst Statistician	257
Current Use Appraiser	259
Personal Property Auditor Appraiser IV	259
Appraisal Systems Analyst	259
Real Property Appraiser IV	259
Commercial Appraiser Specialist	260
Industrial Appraiser	261

#### 1.0 Health and Safety.

The parties agree that health and safety issues, including air quality, will be a high priority subject for Labor/Management meetings (Article 5) during the term of this Agreement. The county shall be responsible for ensuring that all work is done in accordance with applicable State, Federal and County health and safety codes, ordinances and/or regulations. Alleged violations of this commitment shall be subject to this Agreement's grievance procedure: provided however, that any disputes which remain unresolved after Step 3 of said procedure are not subject to binding arbitration.

#### 2.0 Pay-related Issues.

**2.1 Licenses and Accreditations.** The County will reimburse or otherwise pay the cost of securing and maintaining accreditation and/or state-certified licenses according to the following chart:

Accreditation (through DOR) or Certified Licenses (DOL)	Applicable Classifications
State-Certified General Real Estate Appraiser License	Real Property Appraiser IV - Commercial Industrial Appraiser Current Use Appraiser Appraisal Systems Analyst
State-Certified Residential Real Estate Appraiser License	Real Property Appraiser IV - Specialist Real Property Appraiser III and II
State Real Property Appraiser Accreditation	All bargaining unit classifications
State Personal Property Appraiser Accreditation	Personal Property Auditor Appraiser IV Personal Property Auditor Appraiser III Personal Property Auditor Appraiser II

2.1.1 The County shall not pay for the cost of a class necessary for an accreditation or license if the class had previously been taken and paid for by the County, but the time within which to receive credit for the class has lapsed.

2.1.2 The County's obligation to pay for testing and related fees under this Section shall be conditioned upon the employee's passing the test and securing the certification.

**2.2 Examination Fees.** The County shall pay the examination fees required for the Real Property Appraisers III and IV required to take and pass the Real Property Appraiser Competency Examination administered by the Department of Revenue.

**2.3 IAAO Membership.** The County will pay fees and dues necessary for one (1) member of the Appraisers Unit to acquire or maintain one (1) membership in IAAO. Members of the Appraisers Unit shall recommend up to the three (3) bargaining unit members to the Assessor in December of each year. The Assessor shall have final approval. The selected member shall have a membership for one (1) year, and membership shall be renewable. The selected member will be expected to give formal presentations and disseminate the information to the Appraisers Unit.

**2.4 Probationary Period.** The initial probationary period for those newly hired into the bargaining unit shall be twelve months. Employees promoted under the Alternate Staffing Article 8.1.3 of this Agreement shall not serve a probationary period following the promotion. All other promotions, including those resulting from a recruitment and selection process, shall serve a probationary period of six (6) months. The probationary periods shall be extended by the length of any unpaid leave in excess of fifteen (15) days occurring during the probationary period.

**2.5 Step Increases.** Step increases equivalent to a one (1) step increase in the salary range for the applicable classification shall be granted to employees after twelve (12)



months at each step in the range, in accordance with Article 12.4 of the Master Agreement, except in the following circumstances:

2.5.1 The Assessor may advance an employee two (2) steps, provided that the Assessor has justified such action in writing to the County Administrator.

2.5.2 The step increase date will remain constant whether the step is accelerated or withheld.

### **3.0 Equipment.**

**3.1 Personal Expense.** Employees shall not be required to purchase at personal expense tools and equipment necessary to do the job. For purposes of this Section, automobiles are not considered tools or equipment.

**3.2** Employees who are required by the County to use their personal vehicles for County business shall be reimbursed for work related mileage. The reimbursement rates shall be adjusted at such times and in such amounts as the IRS-approved mileage reimbursement rate is adjusted. The rate for established properties shall be five cents more than the IRS mileage reimbursement rate; the rate for new construction shall be seven cents more.

**3.3** Assignment of pool vehicles and use of personal vehicles on County business shall be at the sole discretion of the County. Employees may be required to use their personal vehicle in carrying out their assigned duties as a condition of employment and in accordance with the terms of this Section and following the Assessor's consideration of the impact upon insurance coverage and car ownership.

### **4.0 Other Employment Practices.**

**4.1 Outside Employment.** Appraisers may act as independent fee appraisers or real estate sales agents outside of regularly scheduled work hours and only for properties outside of Clark County boundaries.

**4.2 Promotional Ladder.** Promotion under this Section shall be in lieu of the posting process for filling vacancies.

4.2.1 Employees classified as Real Property Appraisers I will be promoted to the next level when they have passed the initial probationary period as described in Article 2.4 of Appendix A, and obtained the required benchmarks as identified below:

4.2.1.1 Achieved the State Appraiser Accreditation.

4.2.1.2 Demonstrated proficiency and working knowledge and ability in assessment software, and spreadsheet and word processing applications.

4.2.1.3 Demonstrated an accurate and consistent understanding and response to supervisory direction, training, and review of work products.

4.2.1.4 Consistently produced complete, accurate, and timely work products with limited supervision.

4.2.1.5 Shown the ability to perform the work at the Appraiser II level as distinguished within the job description.

4.2.2 In recognition that these promotions require employees be provided opportunities to develop the skills and tools to perform successfully and independently at the next level, promotions to the Appraiser II level delayed beyond one year of service at the I level must be stipulated in writing and be presented to the employee at least thirty (30) days prior to the eligibility date. The employee must be informed as to why the promotion is being withheld, what action he/she must take to obtain the promotion and the date on which the employee will next be eligible for consideration for the promotion.

4.2.3 In all other circumstances, provided the Appraiser I has the required state accreditation and the required benchmarks noted above, promotion to the II level shall occur after no more than two (2) years as an Appraiser I.

4.2.4 Employees classified as Real Property Appraisers II will be eligible for promotion to the Appraiser III level provided they have obtained state accreditation and have demonstrated the ability to perform all tasks at the Appraiser III level with independence and met all requirements of the position as described in that job description.

4.2.4.1 Employees classified as Appraiser I or II prior to January 1, 2013, will be promoted as an Appraiser III level after no more than two (2) years of service as an Appraiser II provided they have obtained state accreditation.

## **5.0 Transfers.**

**5.1** "Transfers within or between classifications" of the Master Agreement shall be amended as follows: When management determines that a transfer opportunity becomes available in the bargaining unit the hiring manager will post the opportunity electronically to the bargaining unit. The electronic posting will identify the position open and the timeline for response. Interested employees must then submit an electronic "transfer form" to the hiring manager within the allotted time limits. An employee who transfers laterally to a new classification shall serve a probationary period of not more than six (6) months. A transfer employee shall have reversion rights to the former position for six months. This provision in no way waives the requirement that an employee serve an initial twelve (12) month probationary period and an employee who has not served a twelve (12) month probationary period will not have reversion rights.

## 6.0 Seniority for Purposes of Layoff.

**6.1** Seniority for purposes of layoff shall be based upon bargaining unit seniority, defined as all continuous service in positions within the bargaining unit since the last date of hire or appointment to a position in the unit with consideration given to breaks in service as identified in this article. The following additional considerations shall apply as warranted:

6.1.1 Bargaining unit seniority shall be calculated based upon continuous service since the last date of hire or appointment into any classification in the bargaining unit.

6.1.2 Seniority shall include time on Workers' Compensation leave and unpaid leaves of absence of fourteen (14) days or less.

6.1.3 Seniority rights shall not be exercised until completion of the required new hire probationary period. Promoted employees do not have seniority rights in the new classification until they complete the probationary period for the classification. Within a classification therefore, probationary employees shall be laid off first, regardless of their bargaining unit seniority. Promoted probationary employees will retain bumping rights within their previous classification.

6.1.4 Employees who resign from County employment in good standing and are subsequently reinstated to their former classification per Section 9.4.11 shall be entitled to bridge their seniority for all purposes except for layoff. The seniority date shall be considered the former date of hire, less the break in service; except that the layoff seniority date shall be the date of reinstatement.

6.1.5 Employees who are laid off and subsequently recalled to County employment within the recall period shall be entitled to bridge their seniority for all purposes, including layoff. Their seniority date for all purposes including layoff shall be considered the former date of hire, less the break in service.

6.1.6 When an entire classification is eliminated and replaced with a new classification seniority in the former classification shall be added to seniority in the new classification.

6.1.7 In the event of a tie in bargaining unit seniority, seniority shall be prioritized as follows:

- a. **Classification Seniority:** Based on total continuous service within the current job classification or homogeneous classification series. Seniority in a homogeneous classification series shall be computed as all time in any of the classifications.
- b. **Department Seniority:** Based on continuous service in the employees current department.

- c. Countywide Seniority: Based on service with the County in any regular position.

## **7.0 Layoff.**

**7.1** The County may layoff an employee based on the elimination of the employee's position due to lack of work, lack of funds, elimination of services/functions or other similar reasons. Additionally, employees may be laid off through displacement by an employee through the bumping procedure outlined in this Agreement. Forced reduction of hours shall also be considered a layoff.

**7.2 Alternatives to Layoff.** The County will make every reasonable effort to avoid layoff of bargaining unit employees. Such efforts will include consideration of the following strategies to prevent or minimize the effects of layoffs:

7.2.1 Termination of temporary employees and consultants.

7.2.2 Temporary voluntary reduction in work hours programs including reduced workweeks.

7.2.3 Attrition-based programs such as voluntary layoffs and voluntary retirements.

The County will solicit Union input as to available and desirable alternatives prior to any final decisions as to the necessity of the layoff. The County will negotiate with the Union any alternative to layoff program that are mandatory subjects of bargaining.

**7.3 Selection of Employees for Layoff.** The appointing authority shall identify by classification the positions to be eliminated. Within classification, employees shall be selected for layoff based on bargaining unit seniority. If a class is part of an alternately staffed classification series, then the position or positions slated for layoff shall be the least senior.

**7.4 Layoff Notice.** Employees are entitled to receive written notice of layoff in advance of the action. The Union shall be notified concurrent with notice to the employee. The length of notice will vary based upon the nature of the layoff and is detailed below:

7.4.1 **Separation from County Service.** Employees who will be separated from County service shall be provided a minimum of twenty (20) working days notice or pay in lieu of notice (one day's pay for each day of notice below twenty).

7.4.2 **Reassignment:**

- a. Employees reassigned to lower classifications shall be provided a minimum of ten (10) working days notice. Employees laterally

reassigned shall be provided a minimum of five (5) working days notice.

- b. Rather than pay-in-lieu of notice, employees reassigned under the layoff article will serve the period of notice.
- c. Contingent Layoff Notices: The County will issue contingent layoff notices to employees whose positions are not being eliminated but who it determines are subject to being bumped by more senior employees. The contingent notice does not replace the notice requirements as specified in Section 7.4.

**7.5 Reassignment to Vacant Position and Bumping.** Employees facing layoff shall be offered reassignment to a vacant position or afforded bumping rights in accordance with the following (a flow chart illustrating this process can be found at the end of Appendix A):

7.5.1 In all cases, claiming vacancies and bumping, the employee must be qualified to perform the duties of the position following a reasonable period of orientation and training.

7.5.2 Employees may only claim vacancies or bump into classifications in which they have formerly served and satisfactorily completed the probationary period except that prior service in any classification that is part of a homogeneous classification series shall be considered as qualifying service.

7.5.3 In the event there is more than one qualified candidate for a position, such position shall be offered on the basis of seniority.

7.5.4 Employees may not bump across homogeneous classification series lines without prior service except that employees may bump less senior employees within/between the Real (II or I) and Personal Property Appraiser II classification series in accordance with the attached flow chart found.

7.5.5 In a bumping situation the employee may only bump when more senior than the employee being bumped.

7.5.6 Employees facing layoff shall be offered reassignment to a vacant position or afforded bumping rights in the order below. The steps below may be rearranged in order to provide a minimum pay reduction:

- a. A vacant position in the classification from which the employee is being laid off.
- b. A vacant position in a lateral classification within the bargaining unit.

- c. An occupied position in a lateral classification within the bargaining unit held by the least senior employee.
- d. A vacant position in the next lower classification.
- e. An occupied position in the next lower classification held by the least senior employee. If a bumping employee is less senior than the least senior employee then the bumping employee will bump into the position held by the least senior employee within the next lower classification, and so on. In the event that the bumping employee is bumping from a classification outside of the homogeneous classification series to position within a homogeneous classification series the bumping employee shall bump the least senior employee within the series and shall be classified at the highest level of the series.
- f. A vacant position in any other formerly held classifications in the bargaining unit.

7.5.7 If there are no available positions in the steps above the County will make every effort to place employees subject to being laid off in other vacant positions for which they are qualified but have no prior service.

**7.6 Recall.** Employees who are laid off, or reassigned, or displaced as a result of bumping, to a lateral or lower classification in lieu of layoff shall be placed on a recall list in order of seniority for the classification from which they were laid off and any former classifications. The recall period shall be two (2) years.

7.6.1 Laid-off employees will be offered employment in any available vacancy in a classification for which they have recall rights provided they are fully qualified following a reasonable period of orientation and training. In the event there are multiple employees eligible for recall within a classification and multiple vacancies available, Human Resources shall coordinate a placement process whereby eligible employees are placed in the most suitable vacancies based on interest, qualifications, and department's needs, provided however that this procedure may not be used to recall a more junior employee in place of a more senior one. The intent of this language is to facilitate voluntary placements within the list of available vacancies and employees who are being recalled. As an alternative to recall, available vacancies may be filled by promotion, transfer from other classifications or departments or demotion of current employees with mutual agreement of the department, Human Resources and the Union.

7.6.2 Laid-off employees are eligible for consideration for other vacancies in the County through the competitive recruitment and selection procedures and shall be allowed to compete as internal candidates for the duration of their recall rights period and will receive preference as provided by Article 9.3.2. Laid-off

employees are responsible for making themselves aware of available vacancies other than those for which they are entitled to recall consideration.

**7.7 Recall Procedure.** Notice of recall shall be sent to the employee by certified mail at the last address reflected in the employee's official personnel file and the employee must respond within fifteen (15) calendar days of the date of the notice. The County may send out multiple recall notices and recall the most senior employee who responds within the allotted time period. An employee shall be allowed to waive one offer but shall otherwise be removed from the recall list for a classification based upon rejection or failure to respond. The employee shall be responsible for notifying the Human Resources Department of any change in address or telephone number.

**7.8 Rights Upon Recall.** Employees who are recalled shall be reinstated with all rights formerly attained including accrued sick leave. The seniority date shall be adjusted to reflect the time on layoff but the employee shall otherwise retain all service credit held at the time of layoff. Employees recalled to their former classification shall be appointed to the step and range formerly held and credit toward the next salary anniversary date shall be continued, not including the time on layoff.

**7.9 Benefits Continuation.** The County shall continue the employer's contribution toward the cost of medical and dental insurance through the end of the first calendar month following layoff.

**Flow Chart - A**

This chart is a graphic illustration of current Local 17 - Appraisal unit contract language

BU = bargaining unit

\* Positions currently not funded and unavailable for layoff purposes

To use this chart, begin at the level of the position being eliminated.

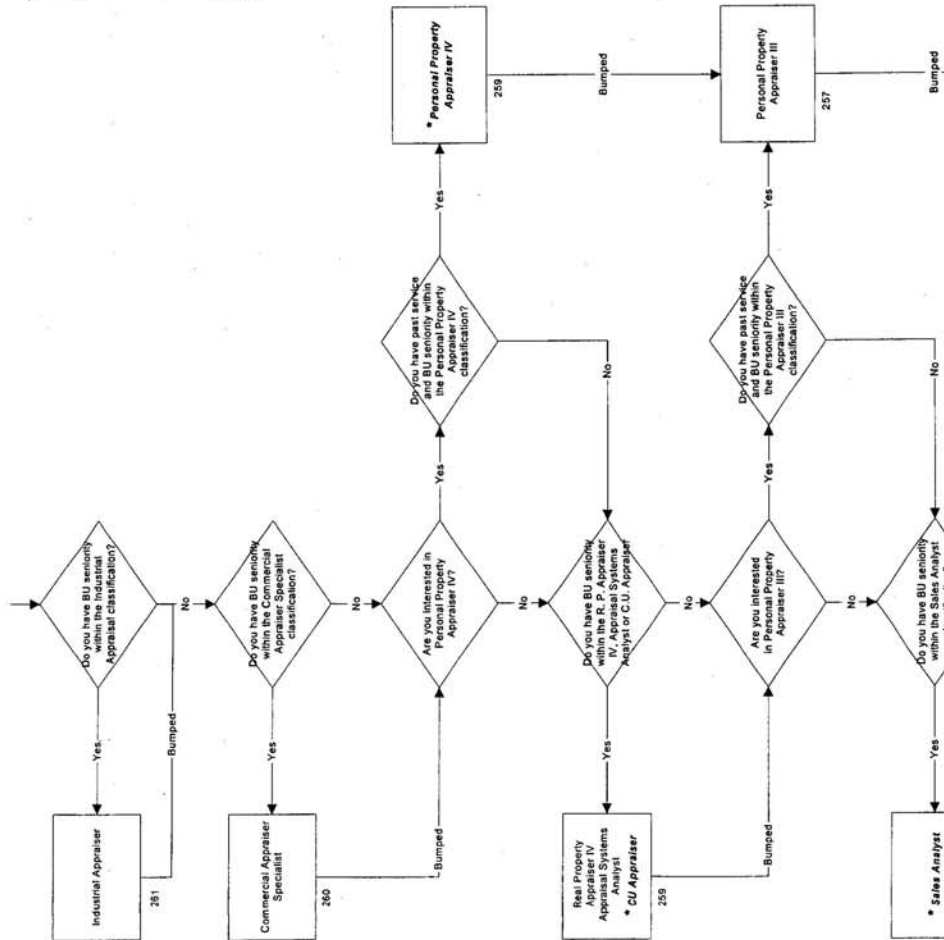



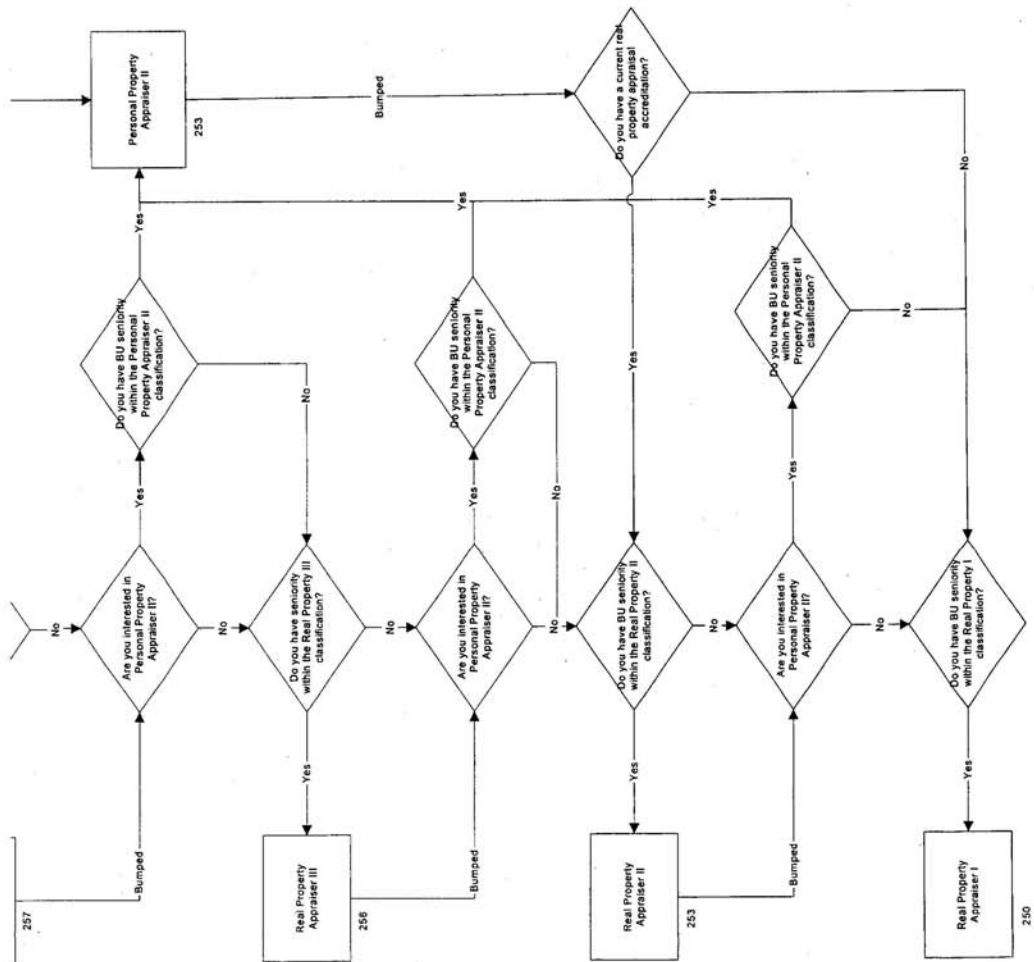

Last Update July 14, 2006

**APPENDIX B**

**between**

**CLARK COUNTY, WASHINGTON**

**and**

**ENGINEERS, TECHNICIANS AND OTHER  
PROFESSIONALS UNIT**

**July 1, 2012 - June 30, 2015**

**Engineers, Technicians, and Other Professionals:** Local 17 Professional and Technical  
Employees

## APPENDIX B

### ENGINEERS AND OTHER PROFESSIONALS

The bargaining unit covered by this Appendix is Engineers, Technicians and Other Professionals and is defined as all regular full time and regular part-time employees in the classifications listed below and represented by the Professional and Technical Employees, Local 17.

#### COVERED CLASSIFICATIONS (range numbers to change in accordance to appropriate rate of pay)

<u>Title</u>	<u>Range</u>
Capital Program Specialist	208
Capital Program Specialist, Senior	211
Capital Project Manager I	208
Capital Project Manager II	211
Capital Project Manager III	214
Engineer I	207
Engineer II	210
Engineer III	213
Asst. Engineering Technician	204
Engineering Technician	207
Senior Engineering Technician	210
Real Property Assistant	200
Real Property Agent I	205
Real Property Agent II	208
Real Property Agent III	210
Design Drafter	207
Traffic Signal Technician	207
Senior Traffic Signal Technician	210
Sustainability Specialist	210
Traffic Engineer	214

**1.0 Health and Safety.** The Union and the County will cooperate in maintaining safe and healthy working conditions. Employees will be encouraged to work in a safe manner. The county shall be responsible for ensuring that all work is done in accordance with applicable State, Federal and County health and safety codes, ordinances and/or regulations. Alleged violations of this commitment shall be subject to this Agreement's grievance procedure: provided however, that any disputes which remain unresolved after Step 3 of said procedure are not subject to binding arbitration.

## **2.0 Equipment.**

2.1 Employees shall not be required to purchase at personal expense tools and equipment necessary to do the job.

2.2 The County retains the exclusive right to assign County vehicles to employees represented by the Union or to restrict, regulate, or rescind such assignments at any time and in any fashion subject to seven (7) calendar days advance written notice.

## **3.0 Transfers.**

3.1 “Transfers within or between Classifications” shall read as follows:

Employees interested in being considered for other bargaining unit positions in equal or lower classifications should submit a transfer request to Human Resources and the applicable hiring manager(s). Such requests shall be kept on file and the department shall consider those requests as positions become available. Transfer requests shall be submitted in writing and shall clearly indicate the classification, position(s) and or work assignments sought. Transfer requests are in the nature of a “standing” request and shall be valid for twelve months for all applicable positions. The employee may re-file or renew a transfer request for succeeding one-year periods.

## **4.0 Probationary Periods**

4.1 The initial probationary period for those newly hired into the bargaining unit shall be six (6) months.

4.2 Employees promoted under Article 8.1.3, Alternate Staffing, shall not serve a probationary period following promotion. All other promotions, including those resulting from a recruitment and selection process, shall serve a probationary period of three (3) months.

4.3 Employees reassigned to a different work team in lieu of layoff or because of lack of work in their current work team shall serve a probationary period of six (6) month. Employees who fail a probationary period under these circumstances shall be subject to Article 6.0 of Appendix B, Layoff.

4.4 Probationary periods shall be extended by the length of any unpaid leave in excess of fifteen (15) days occurring during the probationary period.

4.5 Probationary periods may be extended by mutual agreement of the employee, the Union, and the County.

## **5.0 Seniority for the Purposes of Layoff.**

5.1 Seniority for purposes of layoff shall be based upon bargaining unit seniority, defined as all continuous service in positions within the bargaining unit since the last date

of hire or appointment to a position in the unit with consideration given to breaks in service as identified in this article. The following additional considerations shall apply as warranted:

5.1.1 Bargaining unit seniority shall be calculated based upon continuous service since the last date of hire or appointment into any classification in the bargaining unit.

5.1.2 Seniority shall include time on Workers' Compensation leave and unpaid leaves of absence of fourteen (14) days or less.

5.1.3 Seniority rights shall not be exercised until completion of the required new hire probationary period. Promoted employees do not have seniority rights in the new classification until they complete the probationary period for the classification. Within a classification therefore, probationary employees shall be laid off first, regardless of their bargaining unit seniority.

5.1.4 Employees who resign from County employment in good standing and are subsequently reinstated to their former classification per Article 9.4.11 shall be entitled to bridge their seniority for all purposes except for layoff. The seniority date shall be considered the former date of hire, less the break in service, except that they layoff seniority date shall be the date of reinstatement.

5.1.5 Employees who are laid off and subsequently recalled to County employment within the recall period shall be entitled to bridge their seniority for all purposes, including layoff. Their seniority date for all purposes including layoff shall be considered the former date of hire, less the break in service.

5.1.6 When an entire classification is eliminated and replaced with a new classification seniority in the former classification shall be added to seniority in the new classification.

5.1.7 In the event of a tie in bargaining unit seniority, seniority shall be prioritized as follows:

- a. Classification Seniority: Based on total continuous service within the current job classification or homogeneous classification series. Seniority in a homogeneous classification series shall be computed as all time in any of the classifications.
- b. Department Seniority: Based on continuous service in the employees current department.
- c. Countywide Seniority: Based on service with the County in any regular position.

## **6.0 Layoff.**

**6.1** The County may layoff an employee based on the elimination of the employee's position due to lack of work, lack of funds, reorganization, elimination of services/functions or other similar reasons. Additionally, employees may be laid off through displacement by an employee through the bumping procedure outlined in this Agreement. Forced reduction of hours shall also be considered a layoff.

**6.2 Alternatives to Layoff.** The County will make every reasonable effort to avoid layoff of bargaining unit employees. Such efforts will include consideration of the following strategies to prevent or minimize the effects of layoffs:

6.2.1 Termination of temporary employees and consultants.

6.2.2 Temporary reduced work hours programs including reduced workweeks and furloughs/shutdowns.

6.2.3 Attrition-based programs such as voluntary layoffs and voluntary retirements.

6.2.4 Reduction of paid leave balances or accrual rates.

The County will solicit Union input as to available and desirable alternatives prior to any final decisions as to the necessity of the layoff. The County will negotiate with the Union to the extent that any alternative to layoff program impacts mandatory subjects of bargaining such as reduced work hours programs or paid leave reductions.

**6.3 Selection of Employees for Layoff.** The appointing authority shall identify by classification the positions to be eliminated. Within classification, the appointing authority shall identify the positions to be eliminated, employees shall be selected for layoff based on seniority.

**6.4 Layoff Notice.** Employees are entitled to receive written notice of layoff in advance of the action. The Union shall be notified concurrent with notice to the employee. The length of notice will vary based upon the nature of the layoff and is detailed below:

6.4.1 **Separation from County Service.** Employees who will be separated from County service shall be provided a minimum of twenty (20) working days notice or pay in lieu of notice (one day's pay for each day of notice below twenty).

6.4.2 **Reassignment:**

- a. Employees reassigned to lower classifications shall be provided a minimum of ten (10) working days notice. Employees laterally reassigned shall be provided a minimum of five (5) working days notice.

- b. Rather than pay-in-lieu of notice, employees reassigned under the layoff article will serve the period of notice.
- c. Contingent Layoff Notices: The County may issue contingent layoff notices to employees whose positions are not being eliminated but who it determines are subject to being bumped by more senior employees.

**6.5 Reassignment to Vacant Position and Bumping.** Employees facing layoff shall be offered reassignment to a vacant position or afforded bumping rights in accordance with the following:

6.5.1 In all cases, claiming vacancies and bumping, the employee must be qualified to perform the duties of the position. Qualified is defined as able to perform the duties following a reasonable period of orientation and training.

6.5.2 Employees may only claim vacancies or bump into classifications in which they have formerly served and satisfactorily completed the probationary period except that prior service in any classification that is part of a homogeneous classification series shall be considered as qualifying service.

6.5.3 Employees may not bump across department lines, except that employees may bump less senior employees, across departmental lines within/between positions in the Engineer or Engineering Technician series.

6.5.4 In the event there is more than one qualified candidate for a position, such position shall be offered on the basis of seniority.

6.5.5 Employees may not bump into occupied positions if there are vacant positions in the same or lateral classifications that are available and suitable.

6.5.6 In all bumping situations, the bumping employee must be more senior than the employee being bumped.

6.5.7 Employees facing layoff shall first be offered reassignment to a vacant position. If there are no vacant positions, bumping rights will be afforded in the order below. The steps below may be rearranged in order to provide a minimum pay reduction.

- a. A vacant position in the classification from which the employee is being laid off, first in the department then in the bargaining unit.
- b. A vacant position in a lateral classification first in the department then in the bargaining unit.
- c. An occupied position in the same classification held by the least senior employee. If the bumping employee is not qualified to perform the

work of the least senior employee, the employee may bump the next least senior employee within the same classification.

- d. An occupied position in a lateral classification held by the least senior employee. If the bumping employee is not qualified to perform the work of the least senior employee, the employee may bump the next least senior employee within a lateral classification.
- e. A vacant position in the next lower classification.
- f. An occupied position held by the least senior employee in the next lower classification. If the employee is not qualified to perform the work of the least senior employee the employee may bump the next least senior employee, and so on. In the event the bumping employee has less seniority than any employee in the next lower classification, or is not qualified, then the bumping employee will repeat the above process in the next lower classification and so on.
- g. A vacant position in any other formerly held classifications in the bargaining unit.

**6.6** If there are no available positions in the steps above the County will make every effort to place employees subject to being laid off in other vacant positions for which they are qualified but have no prior service.

**6.7 Recall.** Employees who are laid off, or reassigned, or displaced as a result of bumping, to a lateral or lower classification in lieu of layoff shall be placed on a recall list in order of seniority for the classification from which they were laid off and any former classifications. The recall period shall be two (2) years.

6.7.1 Laid-off employees will be offered employment in any available vacancy in a classification for which they have recall rights provided they are fully qualified following a reasonable period of orientation and training. In the event there are multiple employees eligible for recall within a classification and multiple vacancies available, Human Resources shall coordinate a placement process whereby eligible employees are placed in the most suitable vacancies based on interest, qualifications, and department's needs, provided however that this procedure may not be used to recall a more junior employee in place of a more senior one. The intent of this language is to facilitate voluntary placements within the list of available vacancies and employees who are being recalled. As an alternative to recall, available vacancies may be filled by promotion, transfer from other classifications or departments or demotion of current employees with mutual agreement of the department, Human Resources and the Union.

6.7.2 Laid-off employees are eligible for consideration for other vacancies in the County through the competitive recruitment and selection procedures and shall be allowed to compete as internal candidates for the duration of their recall rights



period and will receive preference as provided by Article 9.3.2. Laid-off employees are responsible for making themselves aware of available vacancies other than those for which they are entitled to recall consideration.

**6.8 Recall Procedure.** Notice of recall shall be sent to the employee by certified mail at the last address reflected in the employee's official personnel file and the employee must respond within fifteen (15) calendar days of the date of the notice. The County may send out multiple recall notices and recall the most senior employee who responds within the allotted time period. An employee shall be allowed to waive one offer but shall otherwise be removed from the recall list for a classification based upon rejection or failure to respond. The employee shall be responsible for notifying the Human Resources Department of any change in address or telephone number.

**6.9 Rights Upon Recall.** Employees who are recalled shall be reinstated with all rights formerly attained including accrued sick leave. The seniority date shall be adjusted to reflect the time on layoff but the employee shall otherwise retain all service credit held at the time of layoff. Employees recalled to their former classification shall be appointed to the step and range formerly held and credit toward the next salary anniversary date shall be continued, not including the time on layoff.

**6.10 Benefits Continuation.** The County shall continue the employer's contribution toward the cost of medical and dental insurance through the end of the first calendar month following layoff.

## **7.0 Other Employment Practices.**

### **7.1 Survey Party-Chief Premium.**

7.1.1 An employee assigned the Survey Party-Chief responsibilities shall receive a 5% premium (approximately one step increase) on all hours worked during the assigned shift.

7.1.2 Assignments will typically be made on a long-term basis (one month or more in duration). Employees on a long-term assignment shall receive the premium rate for paid leave (holiday, sick, vacation, etc.). Employees on short-term assignments (i.e. filling in due to vacation or sick leave; special assignment of short-duration during peak seasons) shall not receive the premium rate for paid leave.

7.1.3 This premium recognizes the Survey Party-Chief's lead responsibilities on the work site. Management retains the right to determine and assign the most qualified employee for this assignment, and retains right to change and/or remove assigned employee based on qualifications and fit.

**7.2 Contracting Out.** Article 4.6 is supplemented as follows: The County shall provide sixty (60) calendar days' notice to Local 17 for Requests for Proposals and Statements of Qualifications. The County shall provide an annual summary of work performed using on-call consulting contracts.

**7.3 Engineering Technician Certification Premium.**

7.3.1 The County agrees to provide a certification premium of 5% for Engineering Technicians achieving one or more certifications. The intent of the certification premium is to acknowledge and reward the added value these provide to work unit and department goals. Certifications which may entitle an Engineering Technician to this premium include those listed below. Other certifications may be added to this list with mutual agreement of the Union and County. An employee receiving certification pay under this Section shall not be required to perform work outside the classification except in accordance with the work out of class provisions of this Agreement.

- a. Through the Washington State Department of Licensing: Professional Land Surveyor, or the Fundamentals of Engineering waiver.
- b. Certification as an Engineer-in-Training through any state certifying agency equivalent to the Washington State Department of Licensing

7.3.2 To be eligible for the certification premium, employees must have a minimum of one year as a Clark County Engineering Technician, provide documentation of a current, active and appropriate certification, be performing satisfactorily, receive annual eligibility approval including the immediate supervisor's verification that the certification is relevant to the employee's work assignment, and not currently be receiving any other premium such as the Survey Party-Chief or Project Manager premiums.

7.3.3 The effective date of the premium shall be the date of submission of the documentation of the certification to the immediate supervisor.

**8.0 Project Management Premium.** The Engineering Division of the Department of Public Works has periodic need for employees to manage identified projects in construction, maintenance and other areas. This need may arise when the volume of projects requiring oversight exceeds the capacity of those regularly designated to manage projects. For purposes of the Project Management Premium program, employees not otherwise expected to manage projects as a part of their classifications may be eligible for premium pay when in Project Management assignments.

**8.1 Eligible Employees:**

All Local 17, PTE members within the Department of Public Works and in one of the classifications listed in Section 8.2 are eligible to work as interim project managers and earn premium pay under the provisions of this Section.

**8.2 Eligible classifications:**

Real Property Assistant	200
Engineering Technician, Assistant	204
Real Property Agent I	205
Design Drafter	207
Engineer I	207
Engineering Technician	207
Traffic Signal Technician	207
Capital Program Specialist	208
Capital Project Mgr. I	208
Real Property Agent II	208
Traffic Signal Technician, Senior	210
Engineer II	210
Engineering Technician, Senior	210
Real Property Agent III	210
Sustainability Specialist	210
Capital Program Specialist, Senior	211
Engineer III	213

**8.3 Eligible Projects:** Any project approved by the Director of Public Works may be considered under this program.

**8.4 Application and Approval Procedures:** Employees who are assigned or who wish to volunteer for this program shall first receive the permission of their Section Supervisor, who will then submit their names in writing to the Project Manager Section Manager for consideration. As projects become available, the Project Manager Section Manager will select the employee based upon input from the manager.

**8.5 Compensation:** Eligible employees approved and assigned to project management responsibilities under this Section will be eligible for premium pay of five (5%) percent. Such pay shall be based on the current hourly rate of pay and will be applied to actual hours worked as Project Manager. The premium pay will be processed through usual timesheet and work order documentation and will be coded as “Work out of Class.”

**8.6 Project Milestones and Cancellation of Premium.** Employees assigned to be project managers under this Section will be measured against their ability to meet project milestones as identified in the Project Scoping Report which includes design, right of way, and construction. The Project Management Section Manager and the Public Works Director will have the sole right to cancel an employee’s participation in the program at any time it is determined the critical milestones are not being met as required under the project.

**9.0 Clothing Allowance.** Engineer and Engineering Technician (series) field employees and Traffic Signal Technicians shall receive reimbursement for up to \$150.00 per year for clothing and boots appropriate to the work.

Employees occasionally assigned to field positions will receive a one-time work boot allowance up to \$100.00 per contract.

**10.0 Shift Differential** See Article 12.12

If the short-term assignment is at management's request and qualifies for overtime payment pursuant to Article 10, Section 10.1.2, then shift differential will not be paid in addition to overtime. If the short-term assignment does not qualify for overtime then shift differential will be paid pursuant to the criteria described in Article 12.

**11.0 Weekend Differential**

Employees who are required to work Saturdays as part of a regularly recurring work schedule will receive an additional \$1.25 per hour for actual hours worked between the hours of 12:00 AM (midnight) Friday night and 12:00 AM (midnight) Saturday night. Employees who occasionally work Saturday for special events will not be eligible for weekend pay in addition to overtime.

**12.0 Standby Pay.** Employees assigned to standby duty shall be compensated at the rate of \$1.50 for each hour on standby. For the purposes of this Section, standby duty assignments are defined as a requirement to remain accessible and available for a specified period (e.g., one week) and employees are required to return to work immediately if called. Employees whose off duty activities are not restricted and are merely subject to being called are not considered to be on standby.

11.0.1 Employees who carry a pager are entitled to standby pay for those time periods when their activities meet the above restrictions.

11.0.2 Employees on standby are entitled to the two (2) hour minimum callback pay for the first call-out in each twenty four (24) hour period of standby duty and each additional callback.

## APPENDIX C

Memorandum of Understanding  
Between  
Clark County  
and the  
Engineers, Technicians and Other Professionals,  
Professional and Technical Employees (PTE) Local 17

RE: Tuesday through Saturday shift for the Sustainability Specialist classification.

Per Article 10.1.1 of the collective bargaining agreement between Local 17 and Clark County, the parties mutually agree to the following principles for scheduling Saturday shifts for the employees hired prior to January 1, 2013:

1. The assignment of a Tuesday through Saturday schedule for one Sustainability Specialist position with an expected duration of March through November of each year. The parties recognize that on weeks when Saturday work is not required, flexibility in the schedule will be permitted providing there are no inherent additional payroll costs to the County.
2. In the event that management determines more than one employee is needed to perform Saturday work, the County will allow for employees who are interested to flex their time to work Saturday shifts, in accordance with Article 10.3.
3. In the event management determines that such employees are not available to flex their schedules and employees are needed to work Saturday shifts, the assignment of overtime will be administered in accordance with Article 11.
4. Management reserves its rights to assign work and modify changes in the work schedule in accordance with the collective bargaining agreement.

Sustainability Specialists hired after January 1, 2013, may be assigned to work a Tuesday through Saturday schedule as needed and with appropriate notification as outlined in Article 10.1.2 of this agreement.

The intent of this MOU is to give the County the ability to assign a Tuesday through Saturday schedule to no less than two Sustainability Specialists as needed to attend weekend community events. If the County is not able to fill vacant positions, up to two employees hired prior to January 1, 2013, may be assigned weekend work.

The County agrees to provide for union input on the assignment process for employees hired prior to January 1, 2013.

Dated this 31 day of Dec, 2012.

For the Union:

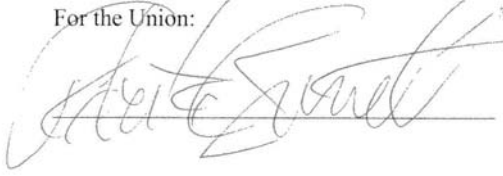

A handwritten signature in cursive script, appearing to read "Mike Swartz", written over a horizontal line.

For the County:



A handwritten signature in cursive script, appearing to read "Kathi Curtis", written over a horizontal line.

## APPENDIX D

### MEMORANDUM OF UNDERSTANDING REGARDING HEALTHCARE BENEFITS

This is a Memorandum of Understanding between the undersigned parties regarding a Clark County Multi-party Healthcare Committee.

**Purpose:** It is the purpose of the Healthcare Committee, working within the negotiated parameters, to seek a balance between the continuance of the quality of care traditionally provided to the County's represented employees and keeping the parties' costs to a minimum, while meeting legal and contractual obligations.

**Committee Membership:** The Committee shall be comprised of two (2) representatives from each bargaining unit (including representation from their respective union staff), two representatives from the ranks of the non-represented employees and up to eight (8) representatives from management provided that bargaining unit representation shall always make-up no less than two-thirds (2/3) of the total membership.

Ratification of this Memorandum of Understanding by the signatories shall empower each party's selected representatives to reach a binding decision. Such decisions shall be reached by a two-thirds (2/3) majority of all members of the Committee present or via proxy. Members who will be absent during a meeting may participate in decisions by submitting a vote by proxy.

One (1) union representative and one management representative will be selected to serve as meeting coordinators who will set meeting times and places, prepare agendas and arrange for meeting minutes to be prepared and distributed.

**Parameters of the Committee:** The Committee is authorized to determine healthcare benefits for the parties based upon the following parameters:

- The Committee shall research and make decisions about the structure, coverage, design, and plans, excluding eligibility, of medical, vision and dental insurances provided to employees.  
\* Any modifications shall not need further ratification by the bargaining units. Any such modifications must be in keeping with the spirit of this MOU as originally created.
- The Committee will be responsible to ensure plan design encompasses federal and state laws.
- [In consideration of the provisions of the Affordable Care Act], a High Deductible Health Plan (HDHP) with a Health Savings Account (HSA) will be included as [and additional] voluntary plan options, along with an HMO plan and a non-HMO plan, no later than January 1, 2014. The particular design elements of the plan will be the responsibility of the Committee.

- The Committee shall determine the cost distribution for the payment of insurance premiums between that portion contributed by the County and that which may be contributed by the employee.
- The Committee shall meet on County time but the County shall not be required to pay overtime to any member due to the scheduling of daytime meetings outside some members' normal work shifts. Committee members meeting outside of their regularly scheduled shift will be permitted to flex or adjust schedules if possible to accommodate meeting attendance.
- As the last item on its agenda, the Committee shall draft and publish an update of the meeting.
- Departments within the County will promptly provide all requested information about insurance that is in the possession of the Departments.
- The Committee will set meeting dates as determined necessary.

**Budget for the Committee:** The County's financial commitment to funding healthcare benefits shall be limited per the Per Employee Per Month (PEPM) budget identified below.

<b>Year</b>	<b>Per Employee Per Month Composite - Budget</b>
2013	\$1,338
2014	\$1,365
2015	\$1,392

- Employees will be responsible for contributing 7% of the composite cost each year; and if costs exceed the composite budget and employee contribution both the County and employee shall share in the excess cost on a 50/50 basis.

**Decision Making:**

- The Committee may choose to work with a Mediator. The Mediator shall not be a voting member of the Committee. However, if the Healthcare Committee is unable to reach a decision for any benefit year by October 1, the Mediator shall direct a solution. Such solution shall be binding on all parties to this Memorandum of Understanding. The Mediator's solution shall be within the parameters outlined above, based upon her/his understanding of the positions of the parties gained through the mediation process. Therefore a formal hearing shall not be necessary.
- If any costs are attached to the mediator's work they shall be paid as follows: Clark County fifty percent (50%); the remaining fees shall be divided equally among the participating units.



This MOU is covered under the grievance provisions of the collective bargaining agreements for purposes of the parties' compliance with the terms and conditions contained herein.

This MOU shall expire December 31, 2015

Signatures:

  
\_\_\_\_\_  
OPEIU Local 11, Office &  
Professional Employees

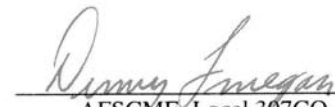
  
\_\_\_\_\_  
AFSCME, Local 307CO, Public Works  
& Community Development

\_\_\_\_\_  
PTE Local 17, Engineers & Other  
Professionals

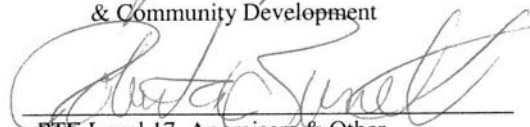
  
\_\_\_\_\_  
PTE Local 17, Appraisers & Other  
Professionals

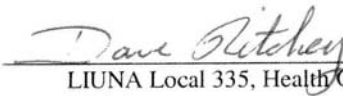
  
\_\_\_\_\_  
LIUNA Local 335, Health Care  
Division

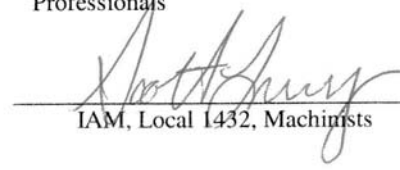
  
\_\_\_\_\_  
IAM, Local 1432, Machinists

\_\_\_\_\_  
Sheriff's Administrator's Guild

\_\_\_\_\_  
Information Technology Guild

  
\_\_\_\_\_  
Juvenile Detention Officers' Guild

\_\_\_\_\_  
Sheriff's Office Support Guild

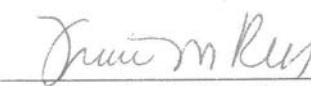
  
\_\_\_\_\_  
Francine M. Reis, Human Resources  
Director

\_\_\_\_\_  
ILWU, Local 8, Medical Examiner's  
Office Unlit

BOARD OF CLARK COUNTY COMMISSIONERS

  
\_\_\_\_\_  
Marc Boldt, Chair

\_\_\_\_\_  
CRESA, Clark County Dispatchers  
Guild

**APPENDIX E**  
**PAID TIME OFF (PTO) Program**

In consideration of the diverse needs of employees, a Paid Time Off (PTO) leave plan has been developed that allows an employee to use a single bank of time for any purpose when scheduled in advance or at times when unforeseen circumstances cause an unscheduled absence.

Paid Time Off (PTO) is used in lieu of the established vacation leave, sick leave and floating holiday within this Agreement. When properly scheduled, PTO can be used for vacations, personal or family business, illness, family illness, doctor's, dentist and eye care appointments and other reasons.

**SCOPE:**

The Paid Time Off (PTO) leave plan applies to full-time and part-time employees who are regular or project employees and recognized in Article 1 to this Agreement.

**“Scheduled” leave** – employee obtains permission from his/her supervisor prior to using leave. Employees must give their supervisor sufficient notice regarding schedule leave. Based on the varying needs, “sufficient notice” will be defined and communicated by each department.

**Sick Leave Reserve (SLR)** – Unused hours that exist in an employee's sick leave bank on the day the PTO plan became effective. Employees do not accrue any additional hours in the Sick Leave Reserve bank and once the hours are exhausted, the bank goes away.

**“Unscheduled” leave** – the employee has not obtained advanced authorization from his/her supervisor to take leave per the requirements under “scheduled” leave (above) and/or does not report to work as scheduled or leaves prior to the end of a scheduled shift.

**ELIGIBILITY AND CONVERSION:**

Upon voluntarily transferring to the Paid Time Off (PTO) leave plan the following shall be in effect:

1. Employees Hired on or after January 1, 2013 will be enrolled in the PTO leave plan.
2. Employees hired prior to January 1, 2013 may elect to transfer to the Paid Time Off (PTO) plan. The County will offer an election period prior to the start of the program to allow employees to elect participation. The County will offer an opportunity to transfer to the PTO plan annually during a designated period to be determined by the Human Resources Department. Following this election period, any transfer elected will become effective January 1 of the following year. Once an employee elects to enroll into the PTO leave plan, it is irrevocable.
3. Employees who voluntarily transfer to the PTO leave plan will have the established leave balances converted as follows:

- Vacation Accrual balance will be converted to the new Paid Time Off (PTO) bank.
- Sick Leave Accrual balance will be converted to the Sick Leave Reserve (SLR) bank.
- Floating Holiday – expires at the end of the calendar year

**Sick Leave Reserve (SLR).** The Sick Leave Reserve (SLR) will reflect the number of sick leave hours transferred as of the day before the employee’s PTO leave plan is implemented. Once an employee transfers to the PTO leave plan, sick leave hours will no longer accrue. Once the sick leave hours are exhausted the SLR will no longer exist.

**PTO ACCRUAL LEAVE SCHEDULE:**

PTO is accrued based on years of service using the adjusted accrual date at the following rates:  
*Hours are accrued on a pay period basis.*

**Full time employees**

<b>Completed Years of Service</b>	<b>Monthly Accrual</b>	<b>Hours Per Year</b>	<b>Days Per Year (based on an 8 hour day)</b>	<b>Maximum Accumulation * (Hours)</b>	<b>Maximum Payout</b>
Start	11.333	136	17	136	136
Year 1	13.333	160	20	320	208
Year 5	15.333	184	23	368	256
Year 10	17.333	208	26	416	304
Year 15	19.333	232	29	464	352
Year 20	21.333	256	32	512	400
Year 25	23.333	280	35	560	448

*Actual accruals will be calculated by the HR/Payroll system, and will be subject to rounding and payroll timing.*

\*The “Maximum Accumulation” will not be paid out beyond the limit stated under the “Maximum Payout” column.

Scheduling of Paid Time Off (PTO) or Sick Leave Reserve (SLR) shall be in accordance with Article 12, Article 14 and Article 15 to this Agreement.

**ACCRUALS:**

Employees accrue PTO while in paid status, whether working or receiving PTO time or other leave such as holidays. Part-time employees accrue PTO on a pro-rated basis based on their FTE or work schedule if working a reduced schedule temporarily. Non-exempt employees will receive a pro-rated accrual if they are in a paid status less than eighty percent (80%) of their regular schedule. Accruals do not occur during an unpaid leave or for hours worked beyond the employee’s regular full time schedule.

Leave cannot be used until accrued, and must be available in the employee's account before available for use; hours accrued in a pay period cannot be used in the same pay period. Eligible employees begin accruing PTO leave from the first day of employment. Generally, employees will not be entitled to use PTO leave until the completion of six (6) months of service; except for sick leave purposes. An exception may be granted for vacation purposes by the Department Head or Elected Official.

Service credit for PTO accrual purposes shall be based upon the adjusted accrual date with Clark County.

#### **MAXIMUM ACCUMULATION:**

Employees may accumulate accrued PTO leave up to the maximum defined under the PTO leave schedule. Accruals cease upon reaching the maximum accumulation. It is each employee's responsibility to monitor his/her PTO leave plan balance.

#### **OTHER LEAVE PLANS:**

The following leave plans are available to employees participating in the PTO leave plan in accordance with this contract or County HR Policy 12: Bereavement Leave, Military Leave, Worker's Compensation Leave, and Unpaid Leave for personal or educational reasons. Protected leaves such as Family Medical Leave, Family Care, and Domestic Violence leave may run concurrent with paid leave.

#### **SCHEDULING AND USE OF PAID TIME OFF HOURS:**

Leave requests must be approved through procedures established by the Department Head or Elected Official. Generally, prior written approval will be expected for anticipated absences such as vacation or scheduled medical or dental appointments. Verbal approval may be allowed at the Department Head's or Elected Official's discretion. PTO shall be charged in increments of one-quarter (0.25) hour, rounding to the nearest quarter hour.

If a holiday recognized under the holiday policy falls on a work day during an approved paid leave, the holiday will not count against the employee's leave bank if the employee would otherwise be eligible for the holiday.

It is recommended that employees maintain sufficient leave hours to cover the disability waiting period, as described in the "Disability Income Benefits" section.

#### **SICK LEAVE RESERVE (SLR):**

Employee's whose leave of absence is approved under Family Medical leave including those with an eligible domestic partner Pregnancy Disability or medical care under the Domestic Violence Policy may access their Sick Leave Reserve bank immediately. In order to accurately be considered and recorded as protected leave, employees must identify the reason for and anticipated duration of their absence when calling in under their department's call-in policy or scheduling in advance.

Employee's whose absences are related to their own illness or injury or that of their family member that is not covered by Family Medical Leave, Pregnancy Disability or Domestic Violence policy as described above, must use PTO for the first twenty-four (24) consecutive work hours for each illness or injury. After twenty-four (24) work hours, employees may access their Sick Leave Reserve (SLR) bank, if available.

#### **DISABILITY INCOME BENEFITS:**

The County provides Disability Income benefits for employees in the event of an illness or injury taking them away from work on an extended basis. Disability benefits are available for qualified conditions as determined by the Disability provider after serving a waiting period of sixty (60) calendar days or total length of leave from the Sick Leave Reserve and accrued PTO leave, whichever is longer; in accordance with the disability insurance contract. Employees will have the option to retain up to forty (40) hours of PTO leave at their discretion. This election must be made at the time of applying for disability benefits.

If approved, and after satisfying the waiting period employees will receive a benefit of sixty percent (60%) of their covered salary (generally base salary). Employees who purchased additional coverage under the Long Term Disability (LTD) Buy-Up plan will receive 66 2/3% of their covered salary. Benefits are paid up to a maximum covered salary of fifteen thousand dollars (\$15,000) per month, (e.g. 60% of \$7,500 mo. salary is \$4,500).

#### **LEAVE DONATION:**

Employees may request leave donation for serious catastrophic health conditions that requires an employee to take an extended leave that qualifies for Long Term Disability (LTD) benefits or for caregiver responsibilities for a covered family member with a severe, extraordinary or life-threatening illness or injury.

Employees may donate from their accrued PTO leave bank up to a maximum of eighty (80) hours in a twelve (12) month period.

#### **HEALTH INSURANCE CONTINUATION DUE TO DISABILITY:**

The County will continue medical and dental insurance for six (6) months when an employee has a serious health condition, and qualifies for Disability benefits provided the employee pays any relevant employee premium. This provision will provide continued coverage after an employee has exhausted use of other programs such as Family Medical Leave.

**PAY OUT AT SEPARATION:**

**1. Paid Time Off:**

Upon separation from County employment, employees with more than six (6) months of service shall be paid for all accrued and unused PTO leave plan hours up to the “Maximum Payout” schedule at his or her final base hourly rate of pay, excluding shift differential or other premium pay.

Employees who transfer from one County department to another are not regarded as having separated from employment and are not entitled to be paid for the accrued leave as a result of the transfer.

**2. Sick Leave Reserve Bank**

Employees hired before the effective date of this policy with a minimum of ten (10) years’ service and who resign in good standing, are laid off, or retire will be permitted to cash out a portion of their accrued but unused Sick Leave Reserve (SLR) bank at their base rate of pay according to the following formula:

<u>Accumulated Hours</u>	<u>Percentage Payable</u>
900 to 1,200	75% of hours over 900
600 to 899	50% of hours over 600
300 to 599	25% of hours over 300

For example, an employee with a balance of twelve hundred (1200) hours would be paid for four hundred and fifty (450) hours: seventy-five percent (75%) of the top bank of three hundred (300) hours = two hundred and twenty-five (225) hours, fifty percent (50%) of the next bank of three hundred (300) hours = one hundred and fifty (150) hours and twenty-five percent (25%) of the next bank = seventy-five (75) hours.

Employees with less than ten (10) years of service will continue to accrue service for eligibility towards sick leave payout as long as they were employed prior to the ratification of this Agreement.

For example: On the date of implementation an employee has five hundred (500) hours credited to their Sick Leave Reserve (SLR) bank. At that time they only have six (6) years of service. The employee will continue to accrue “service years” for each year they continue to be employed even though they are not accruing additional hours in the Sick Leave Reserve (SLR) bank.

**TRANSFER TO NEW DEPARTMENT:**

Accrued and unused Paid Time Off (PTO) and Sick Leave Reserve (SLR) hours shall move with an employee who is transferring from one County department to another County department.

**LEGAL REQUIREMENTS:**

Policies and programs addressing the use of sick leave including the attendance policy and sick leave payoff program shall be interpreted and modified as necessary to ensure compliance with federal and state laws including the American with Disabilities Act, the Family and Medical Leave Act, and the Family Care Act.